

A

B

C

D

E

F

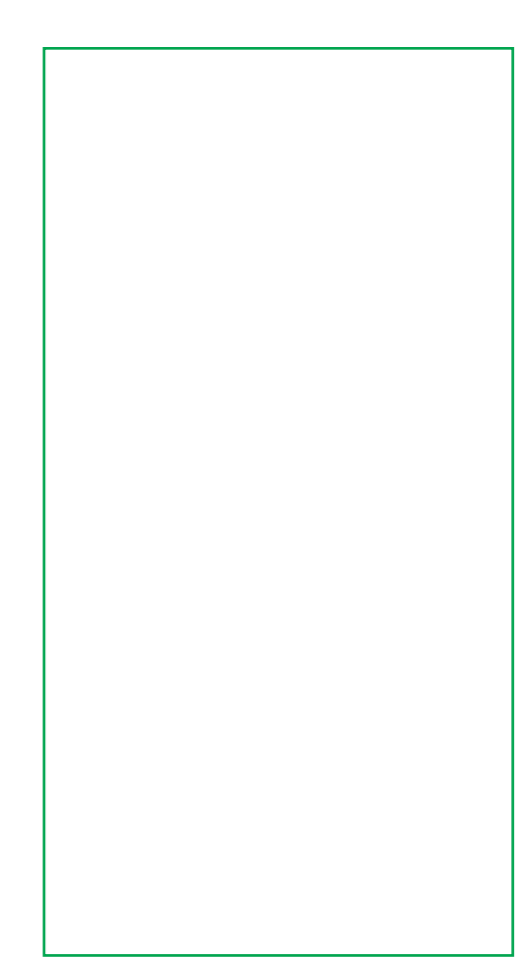

封面

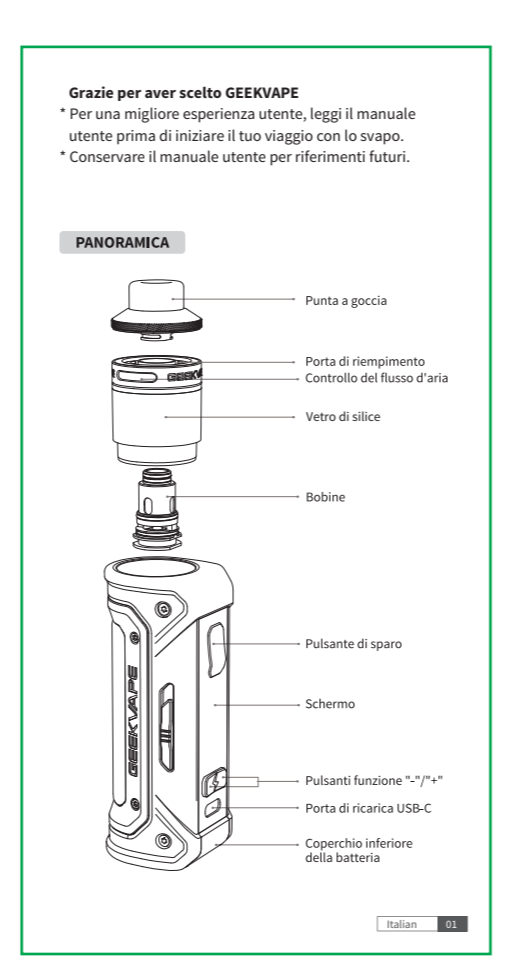

意大利语

29

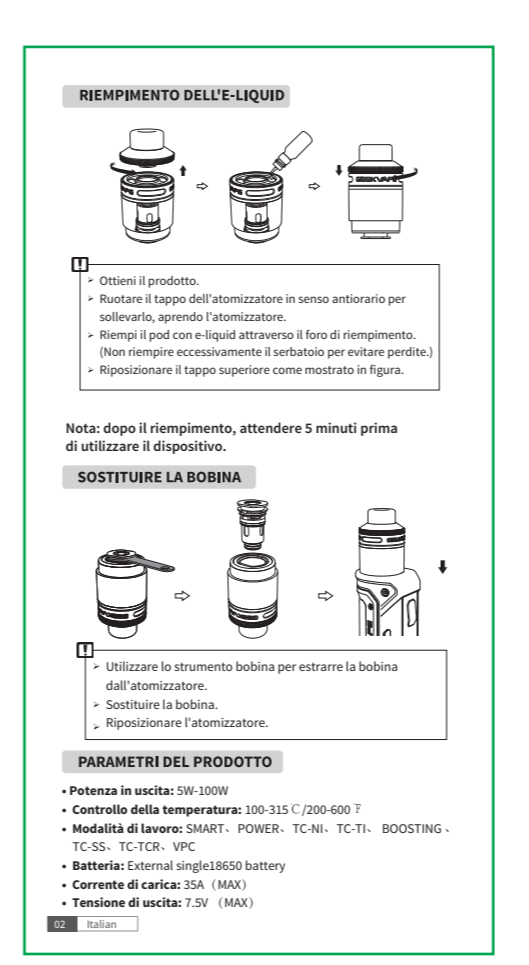

30



31

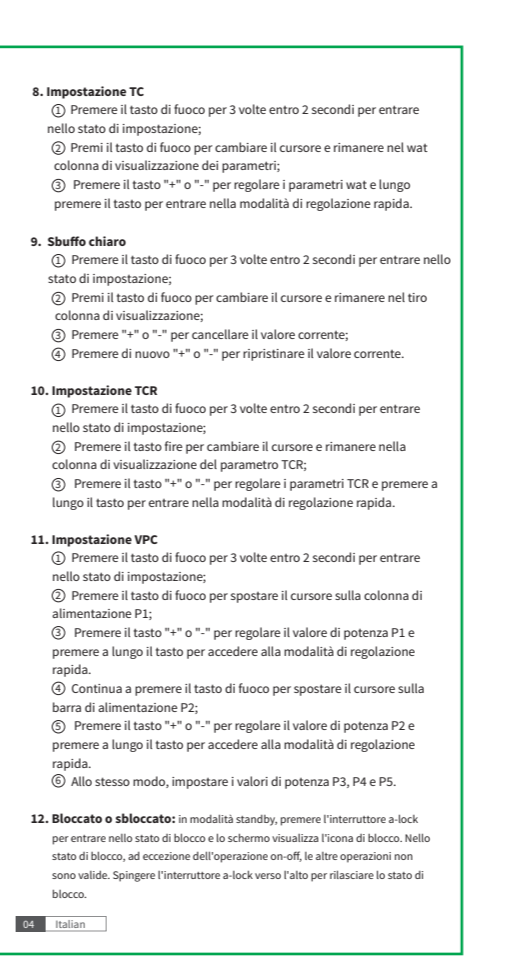

32

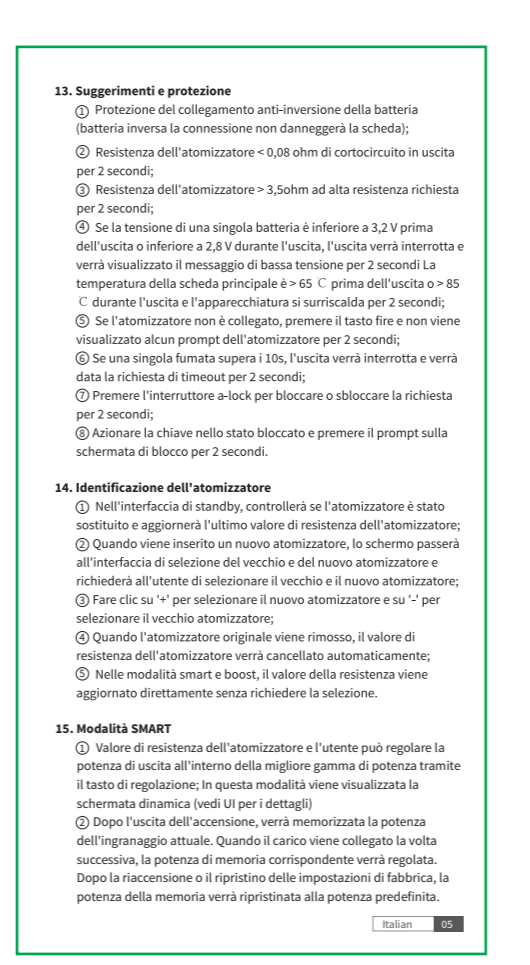

33

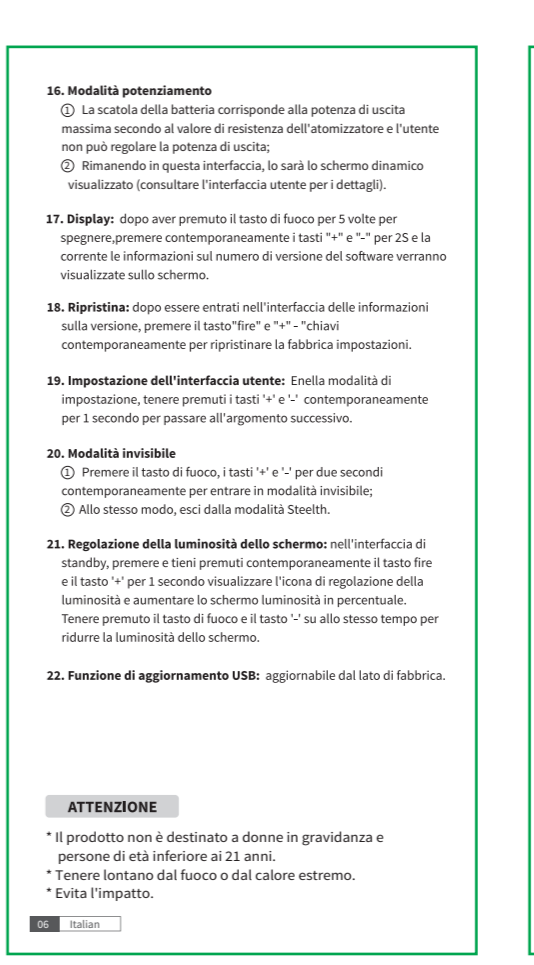

34

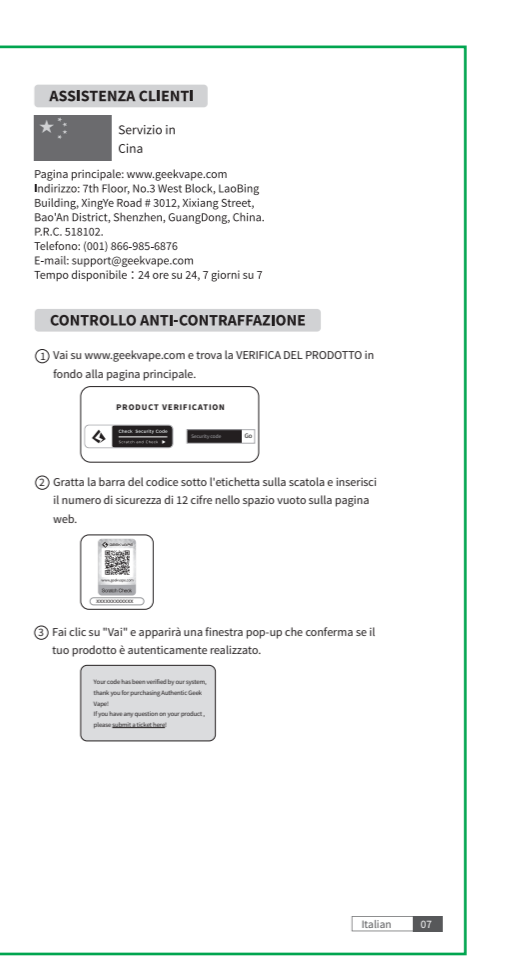

35

4

英语

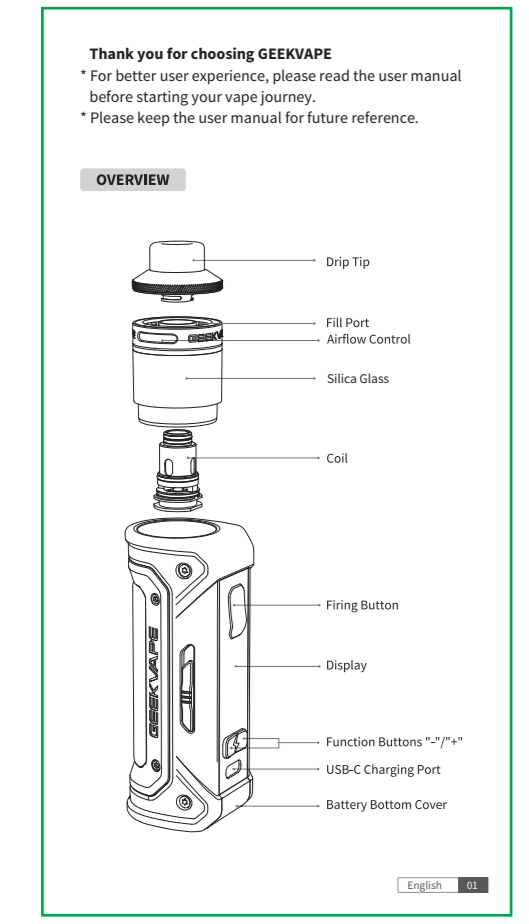

1

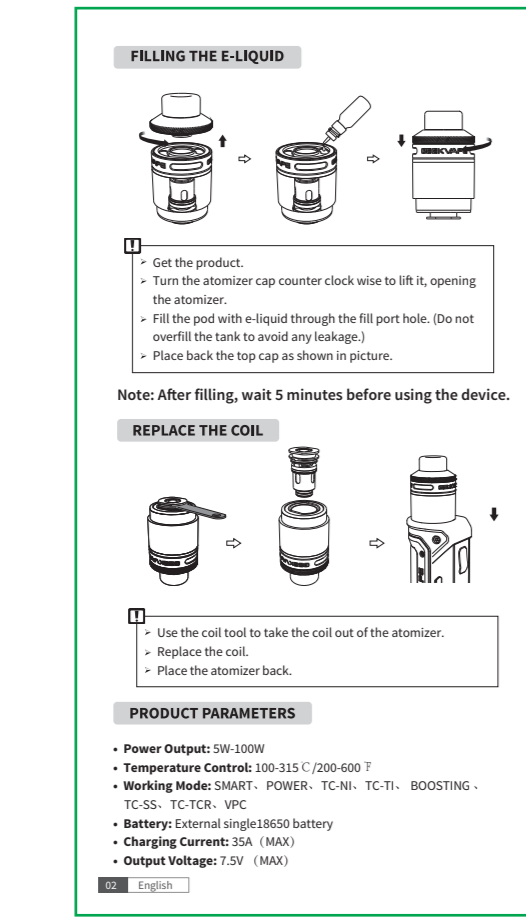

2

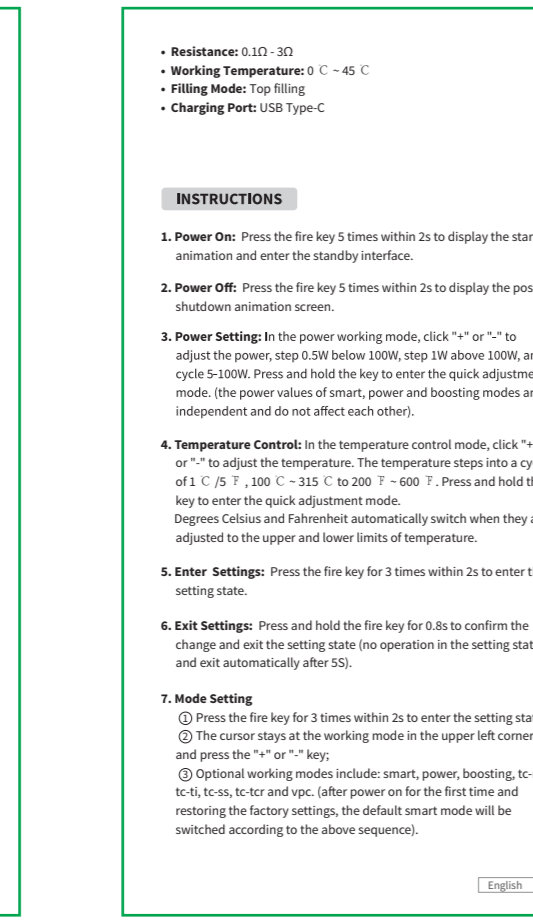

3

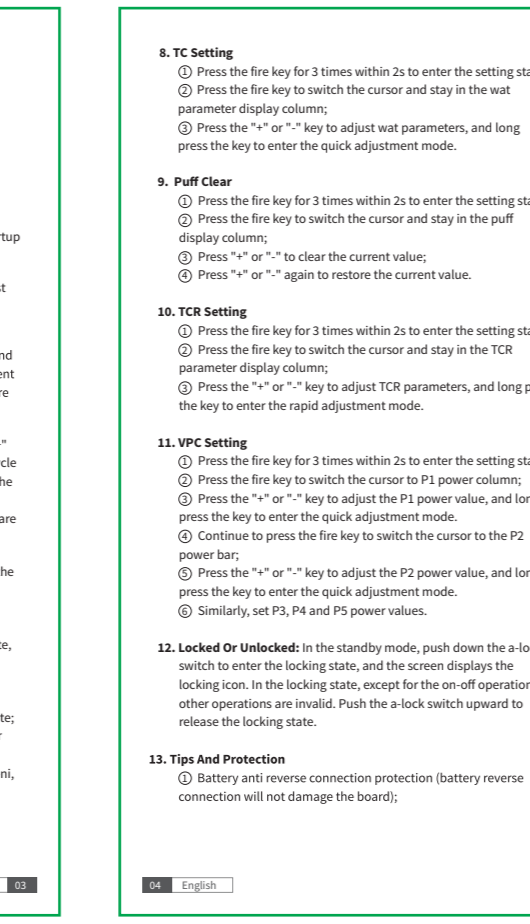

4

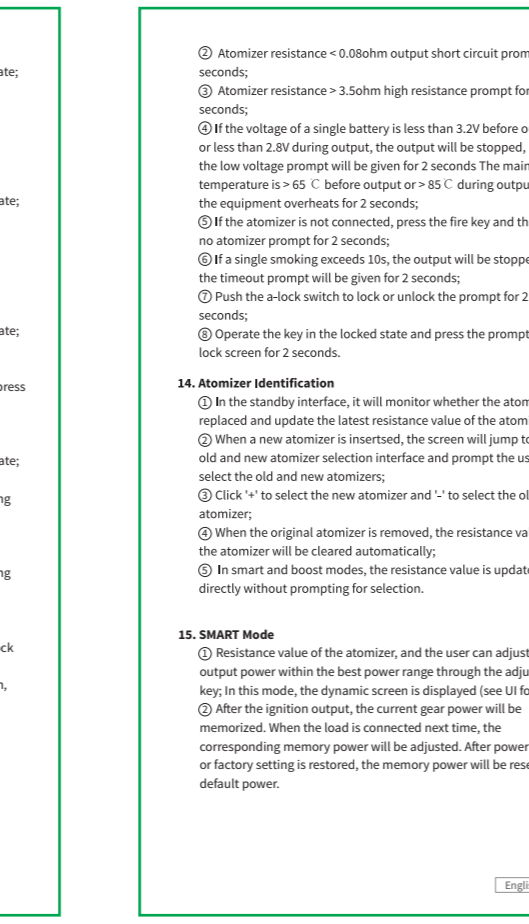

5

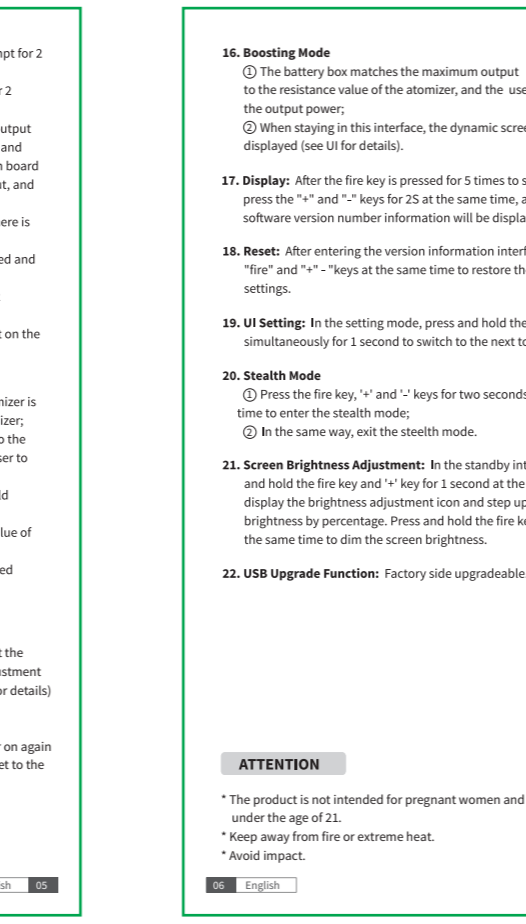

6

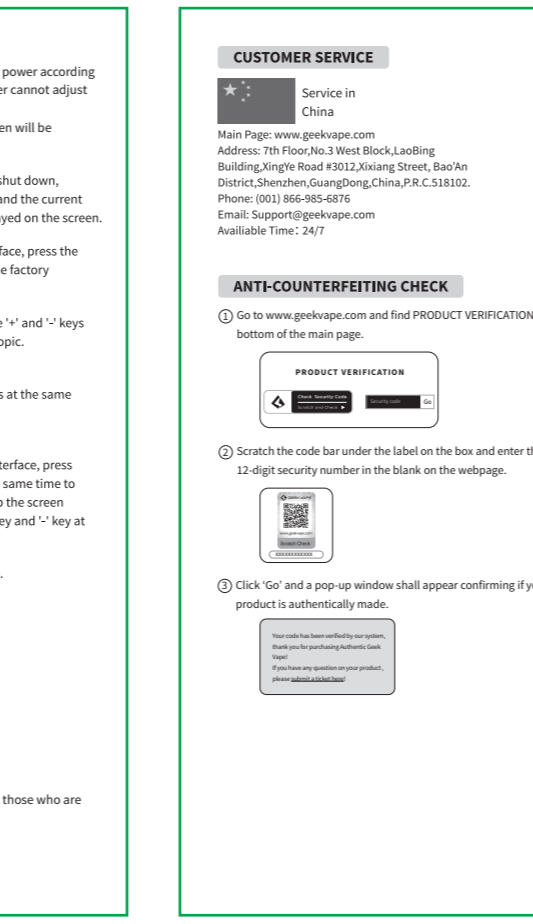

7

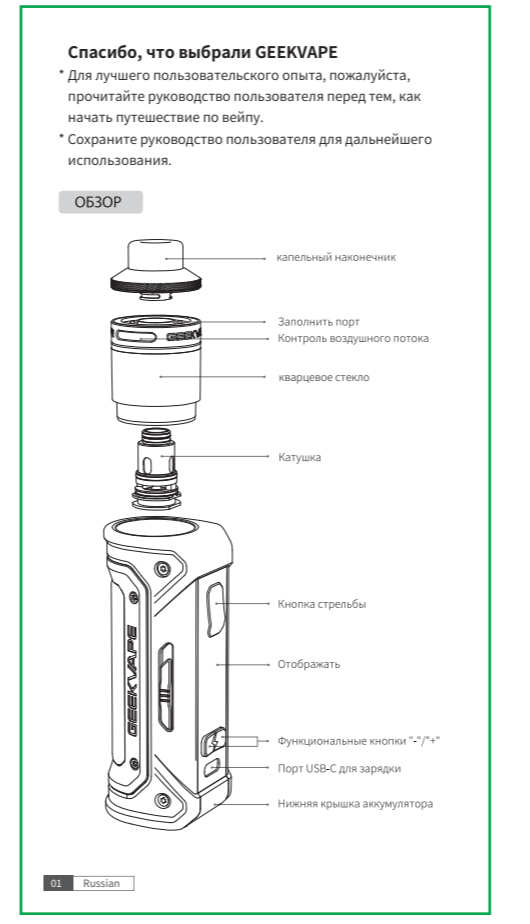

俄语

36



37

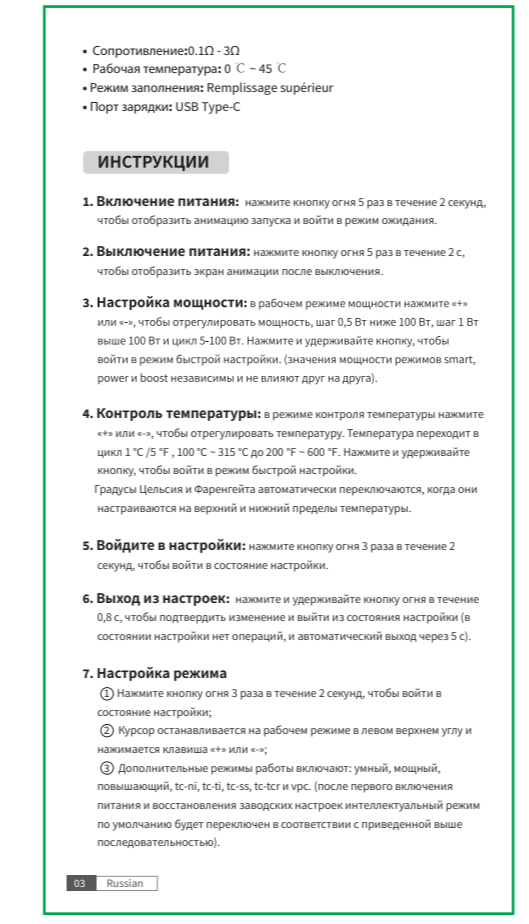

38

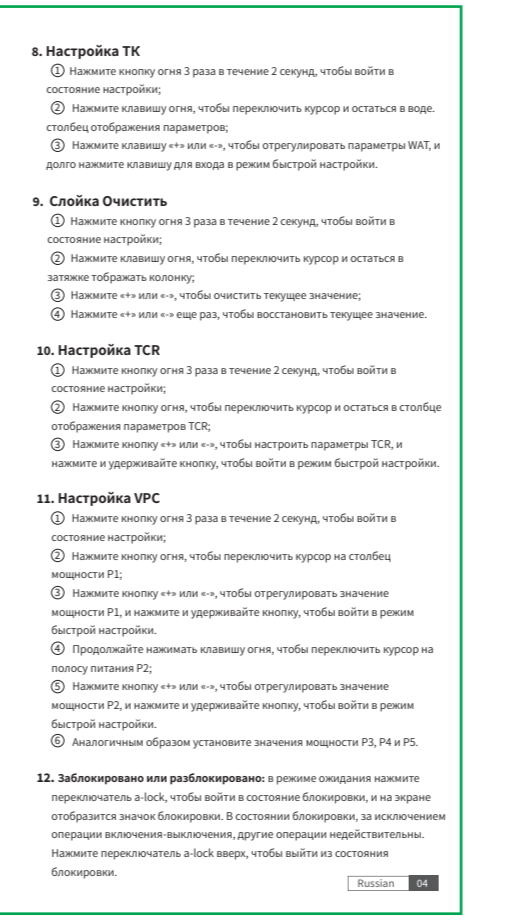

39

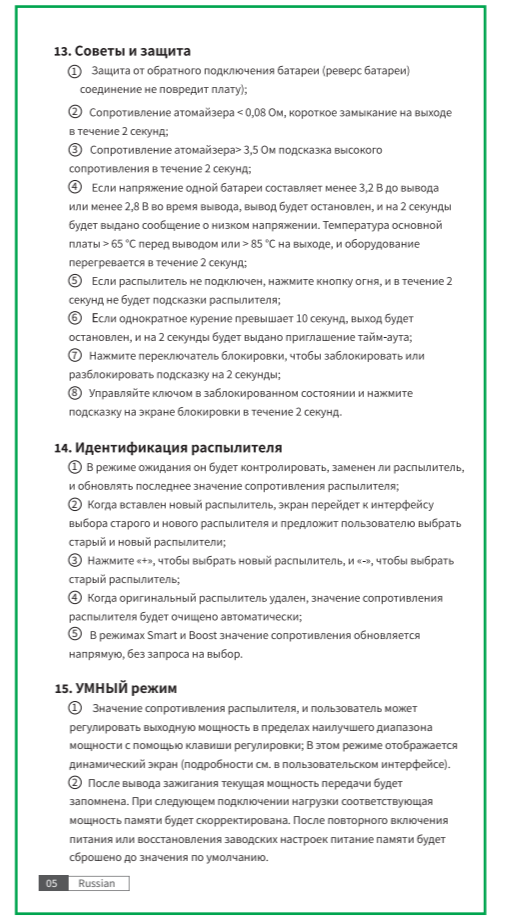

40

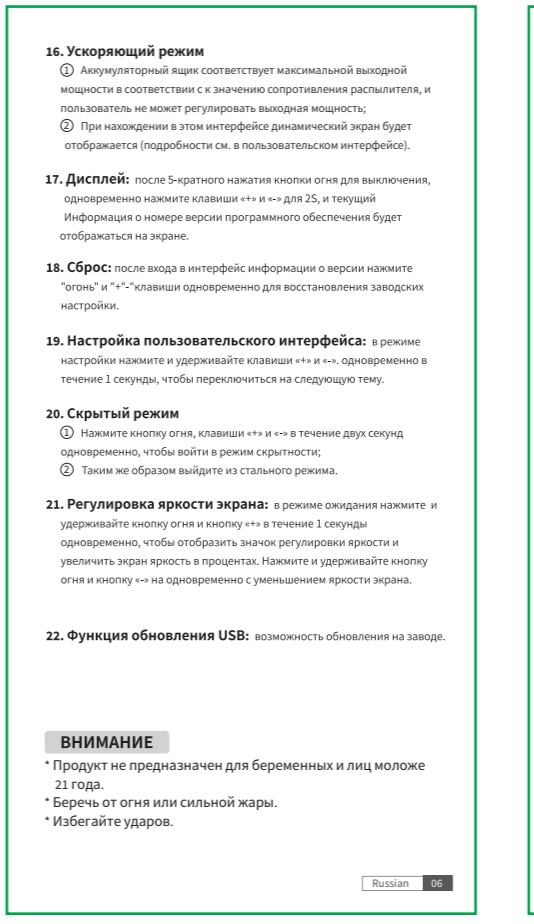

41

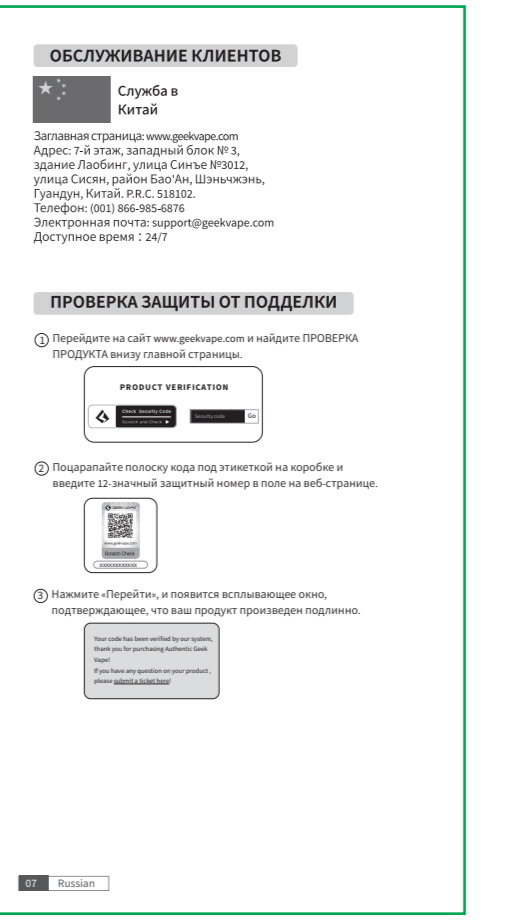

42

3

法语

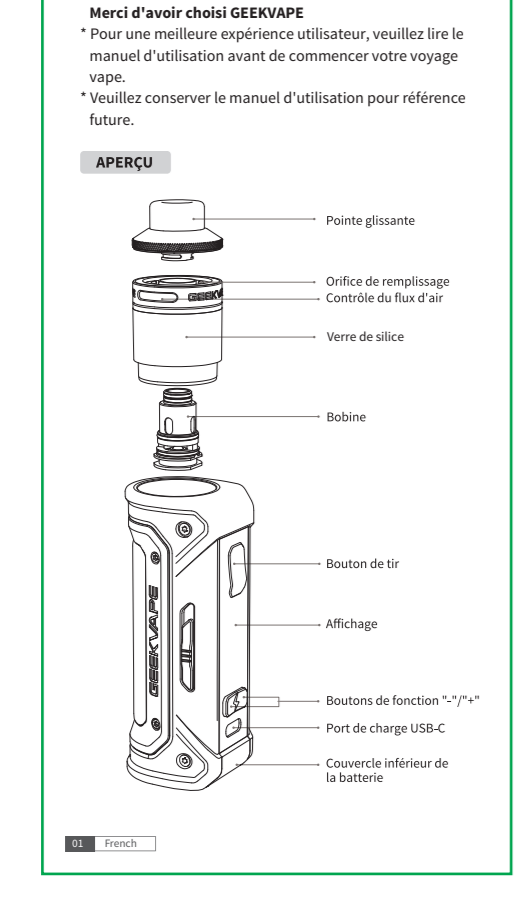

8

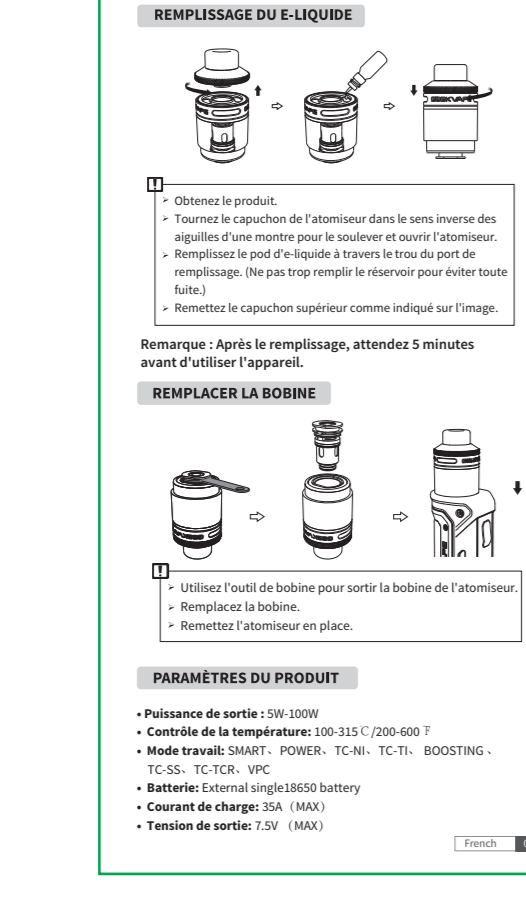

9

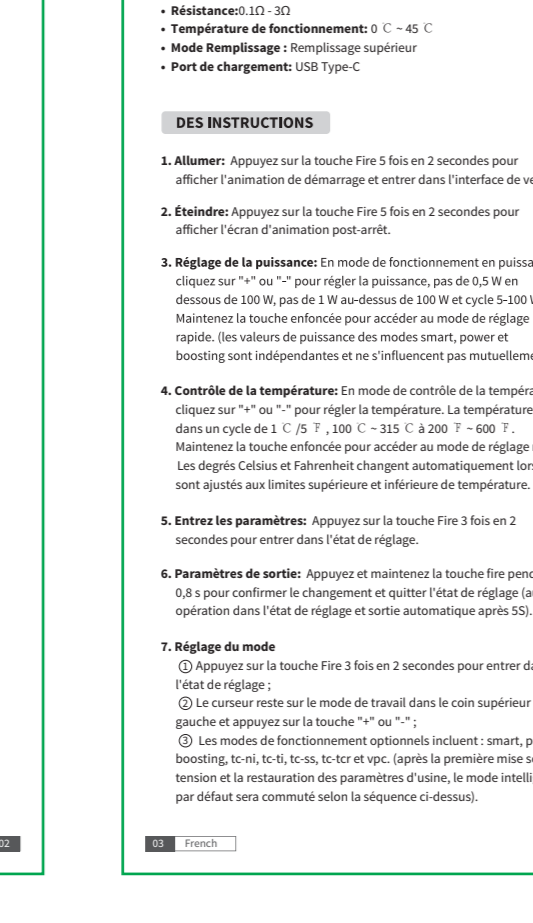

10

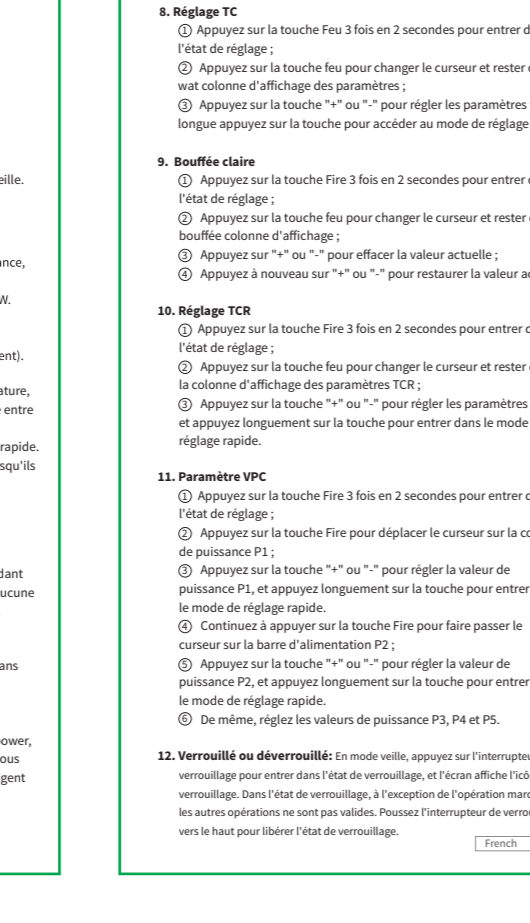

11

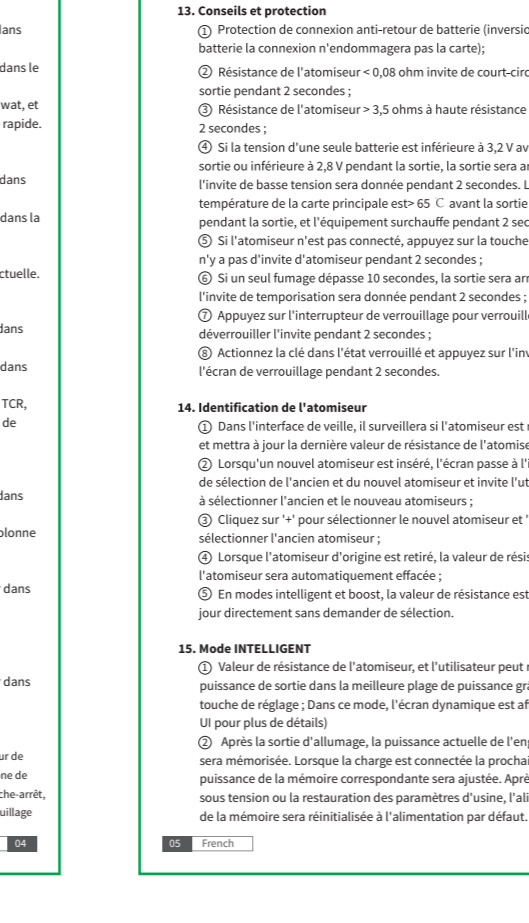

12

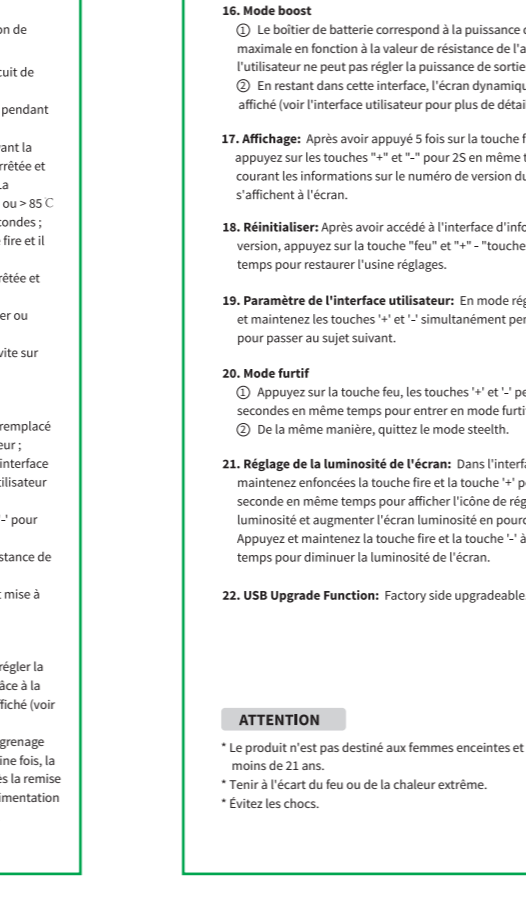

13

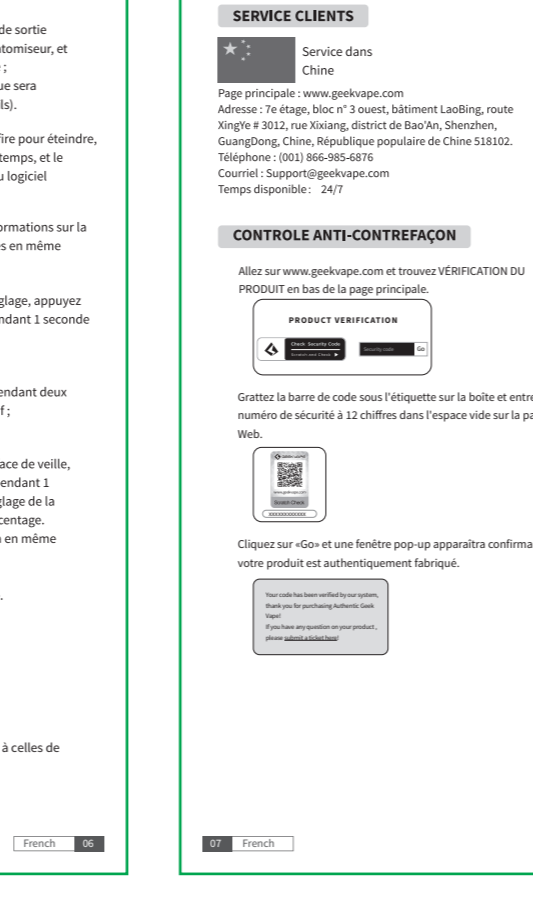

14

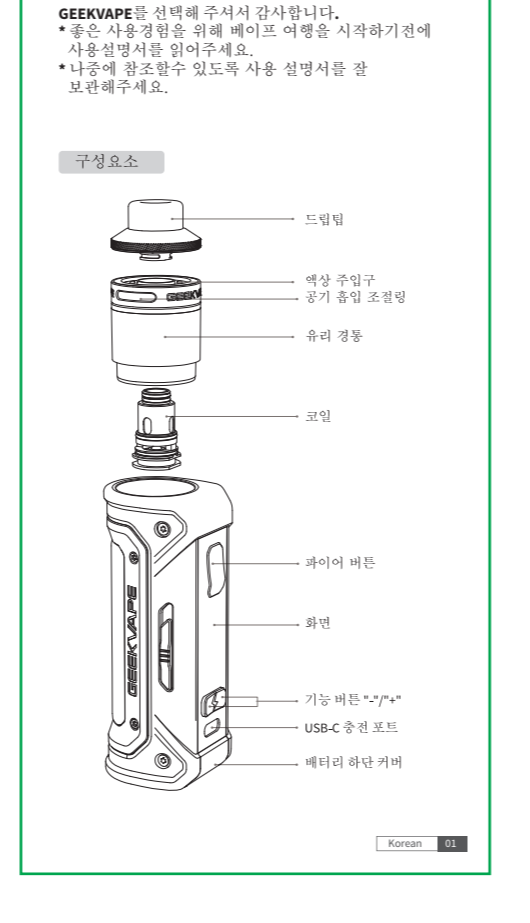

韩语

43

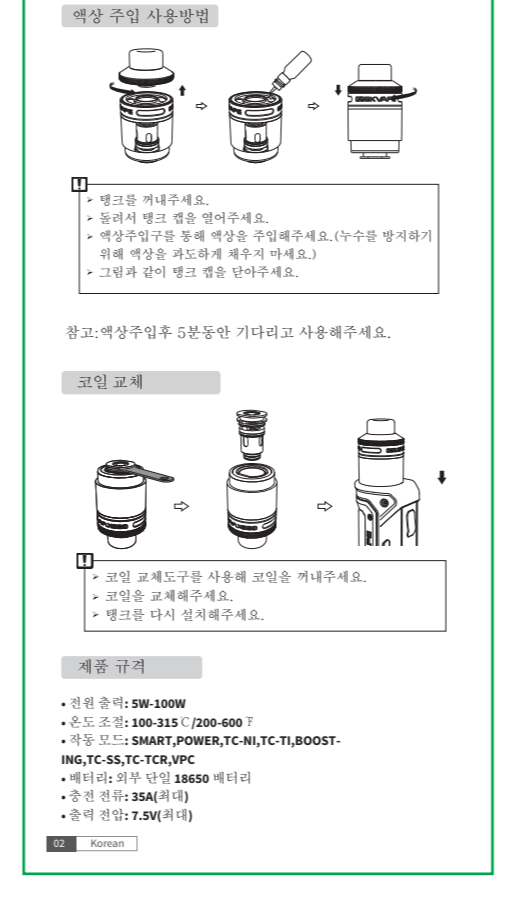

44

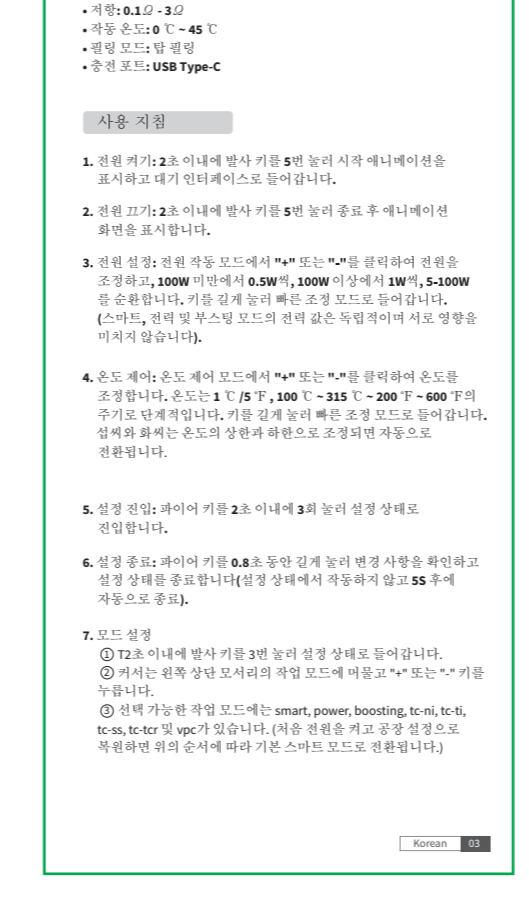

45

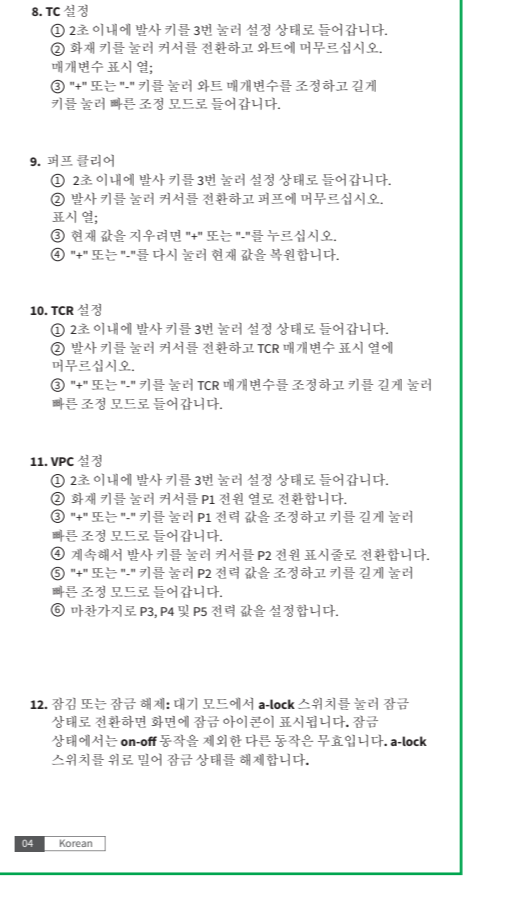

46

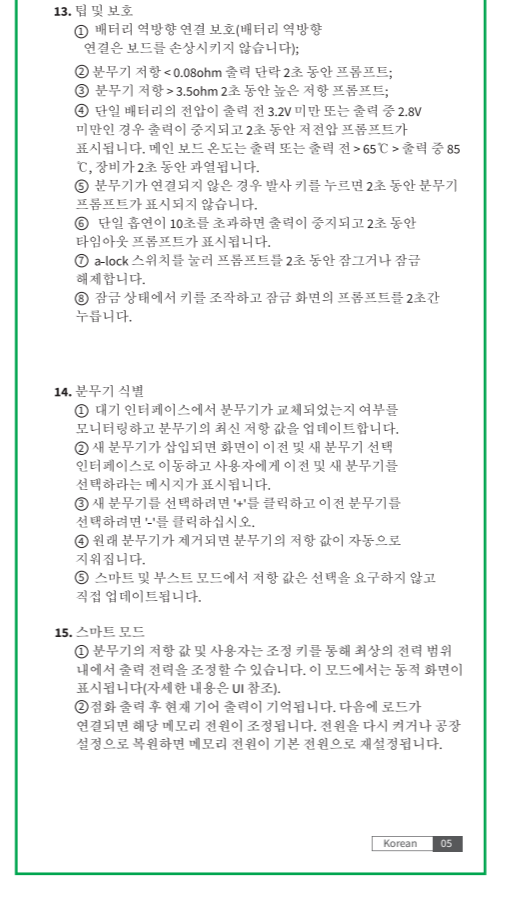

47

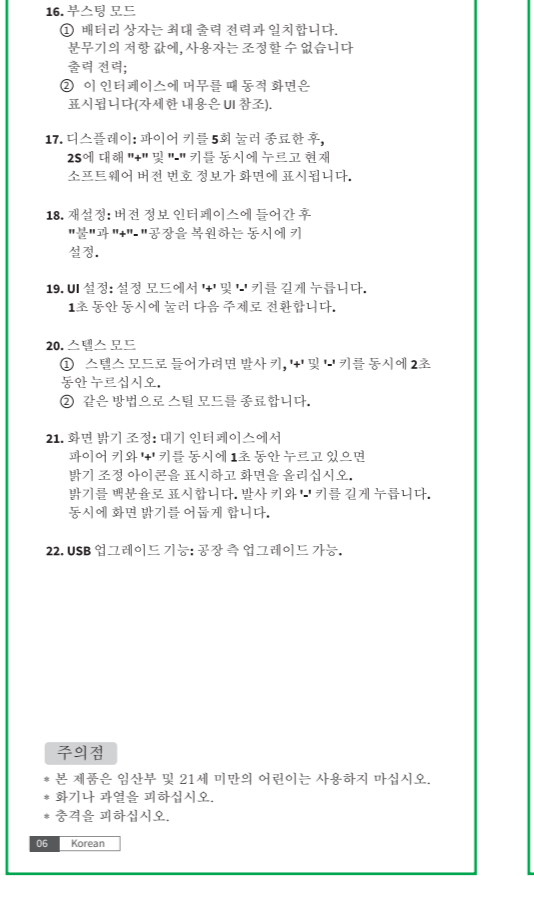

48

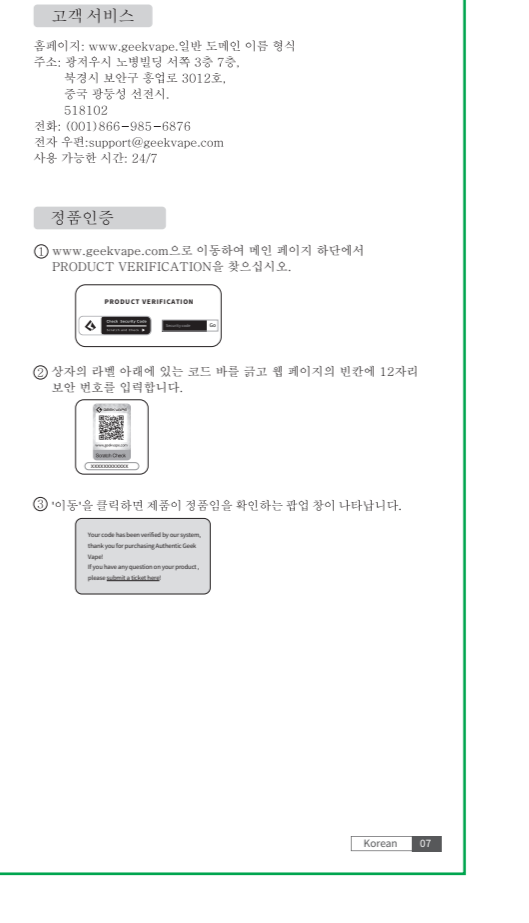

49

2

德语

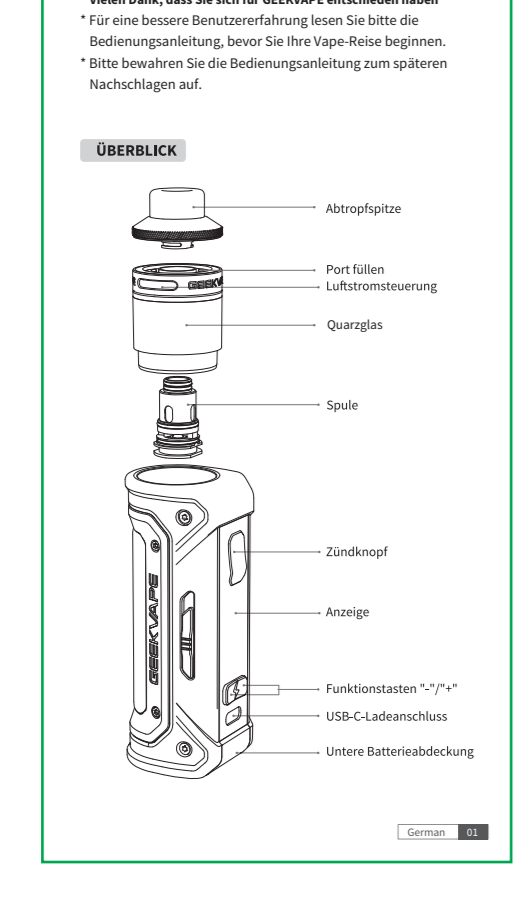

15

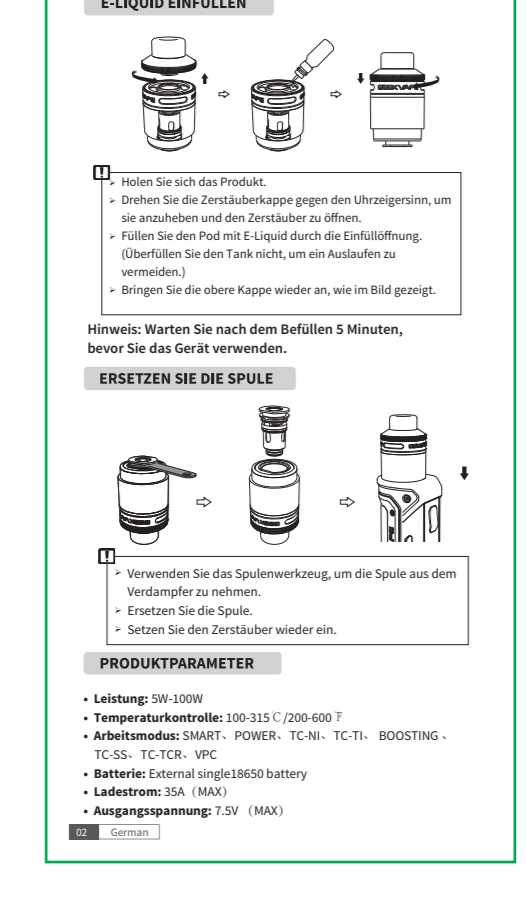

16

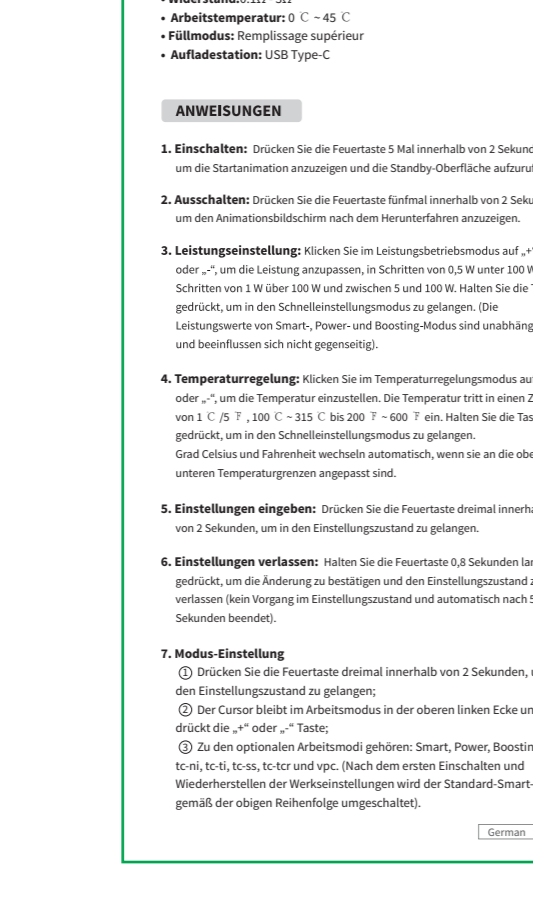

17

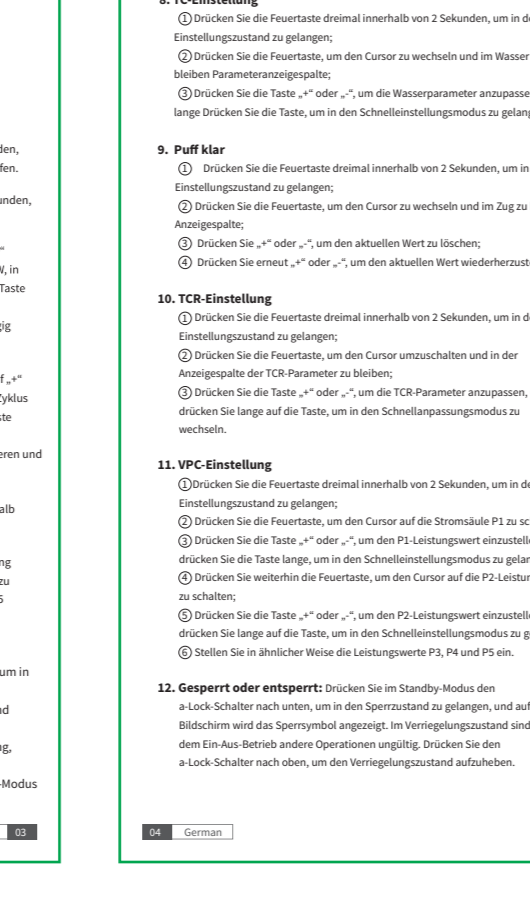

18

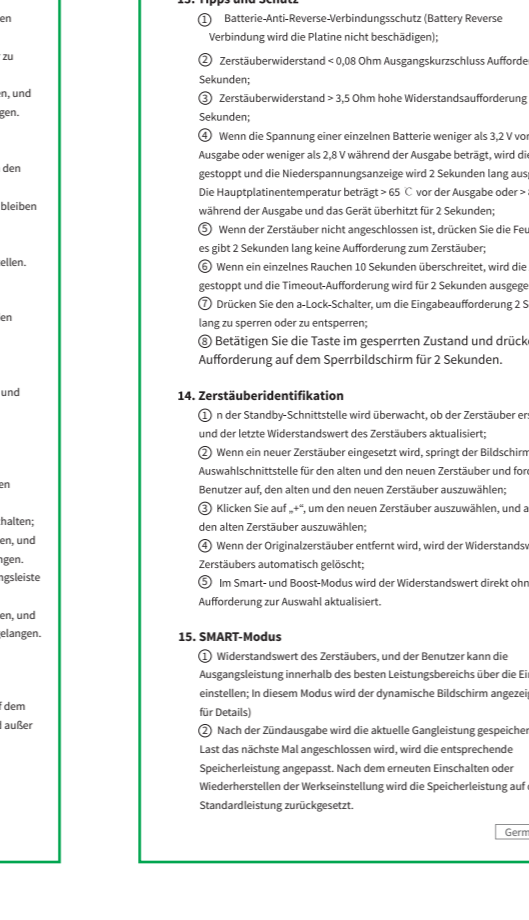

19

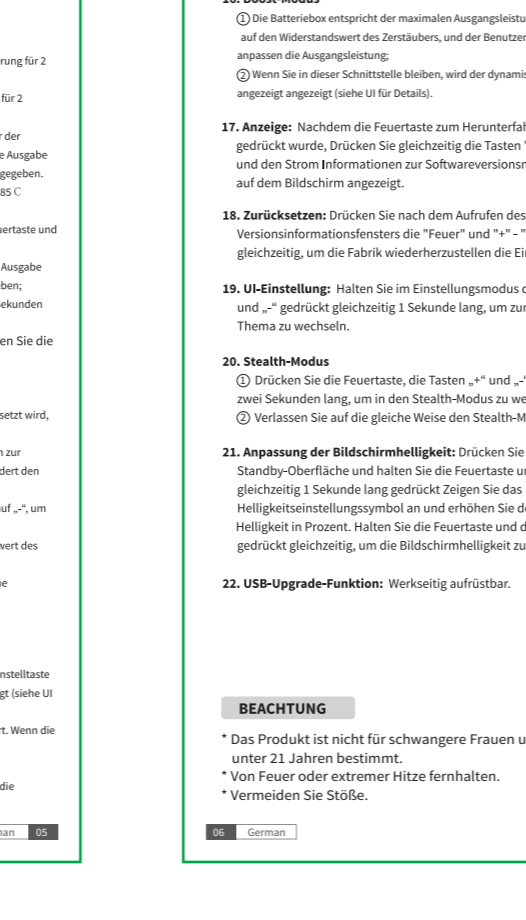

20

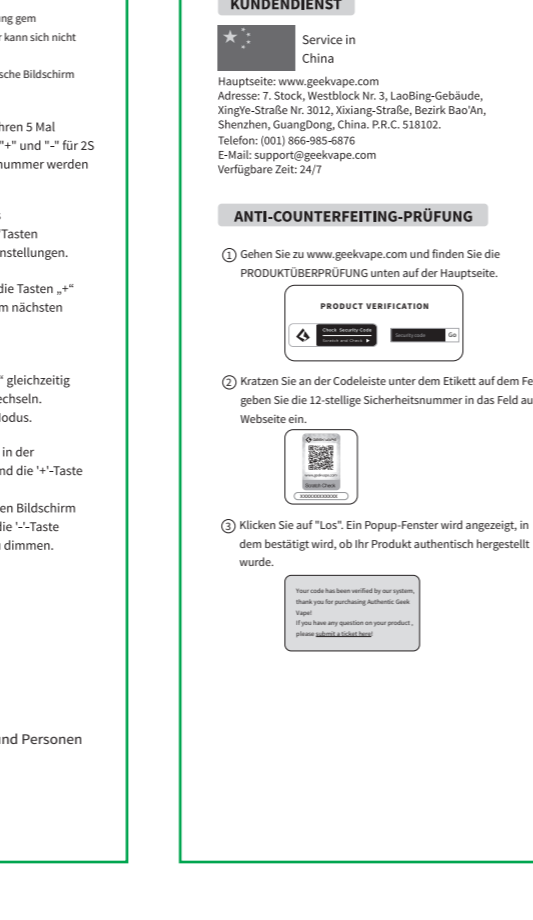

21

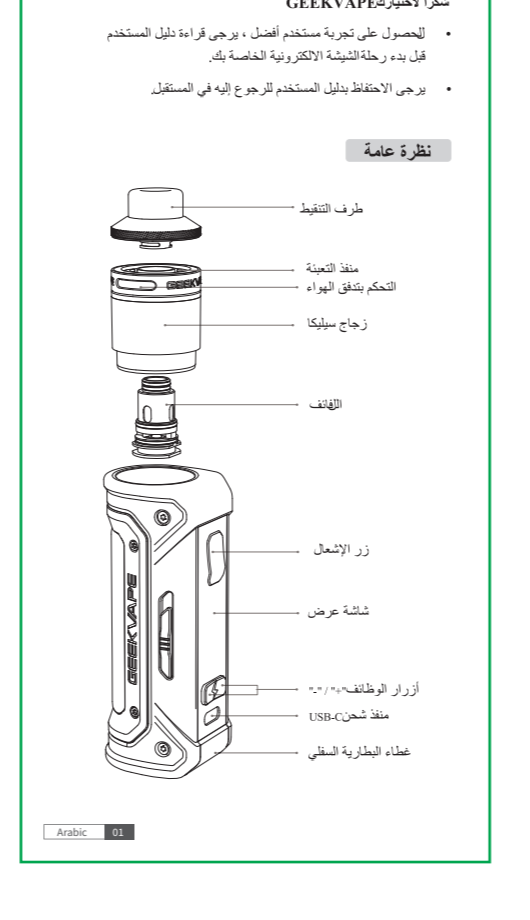

阿拉伯语

50



51

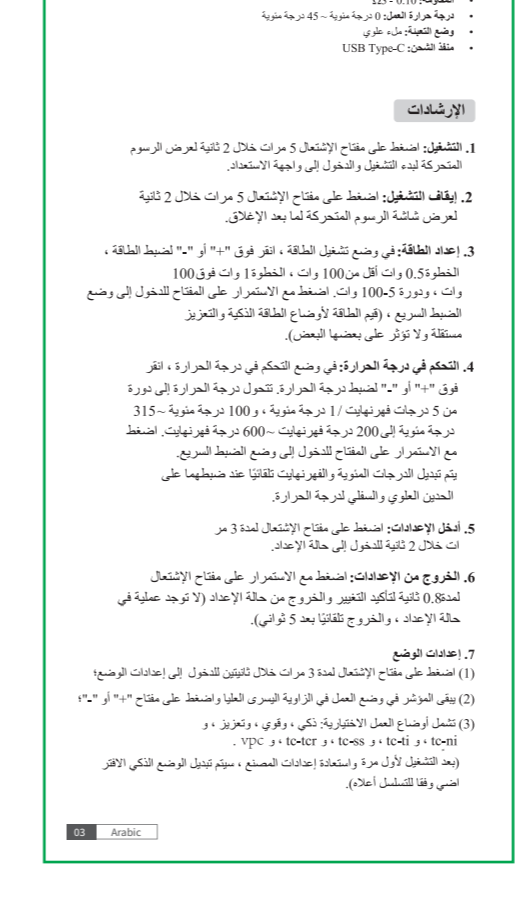

52



53



54

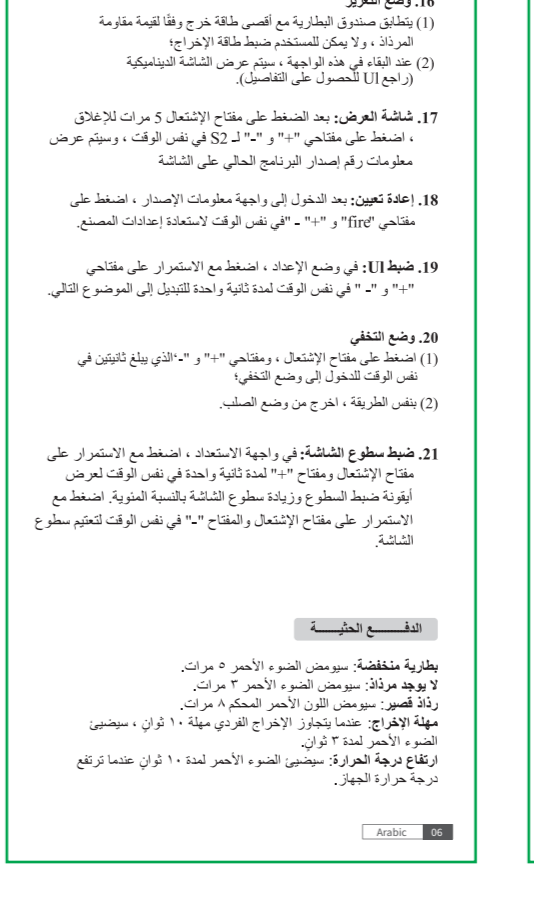

55



56

西班牙语

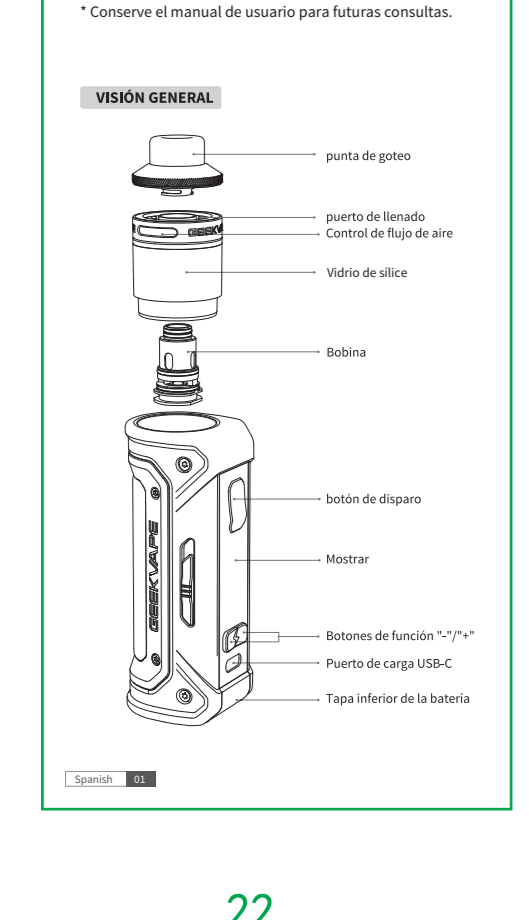

22



23

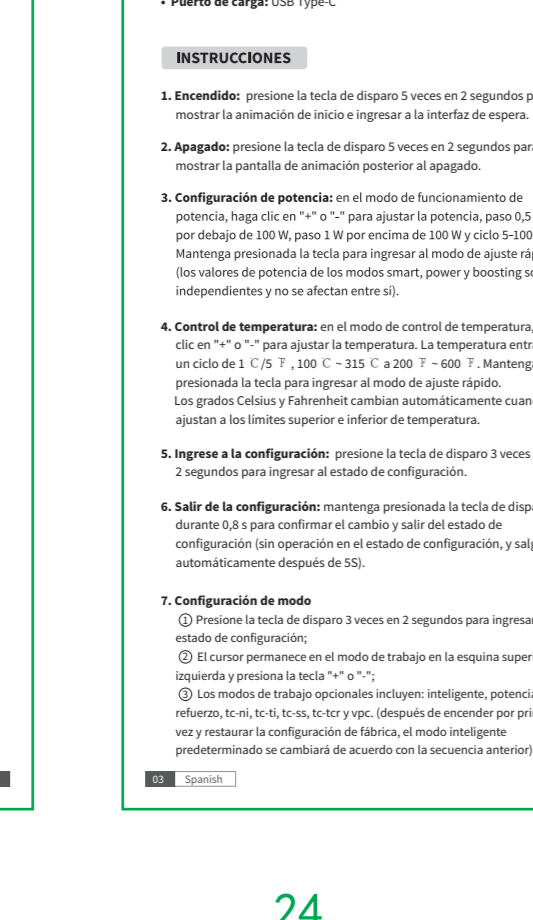

24

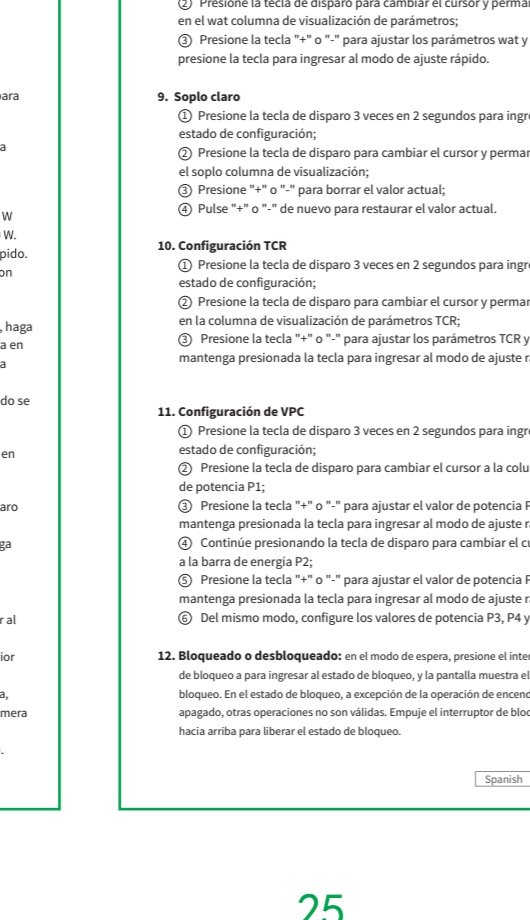

25

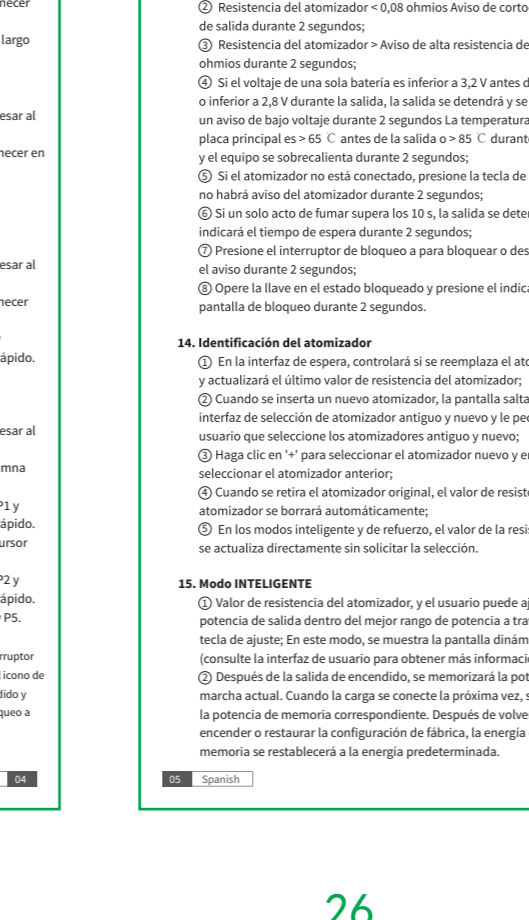

26

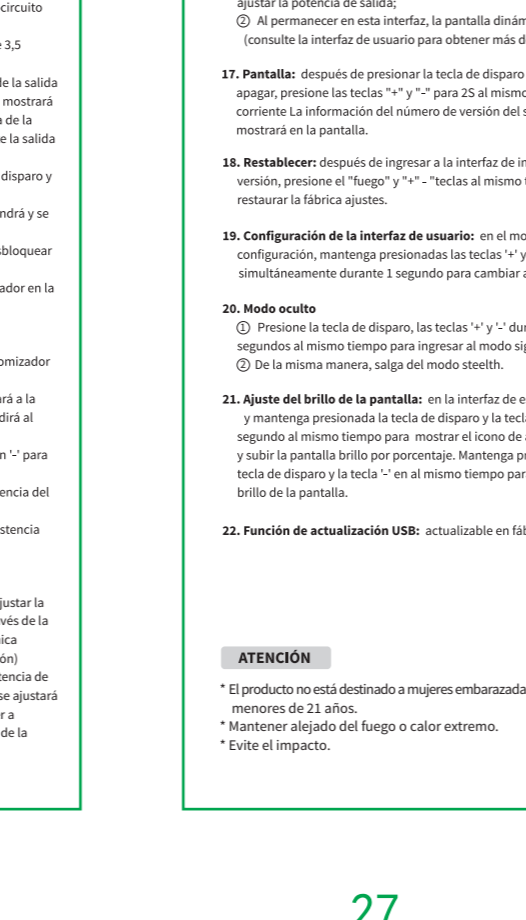

27

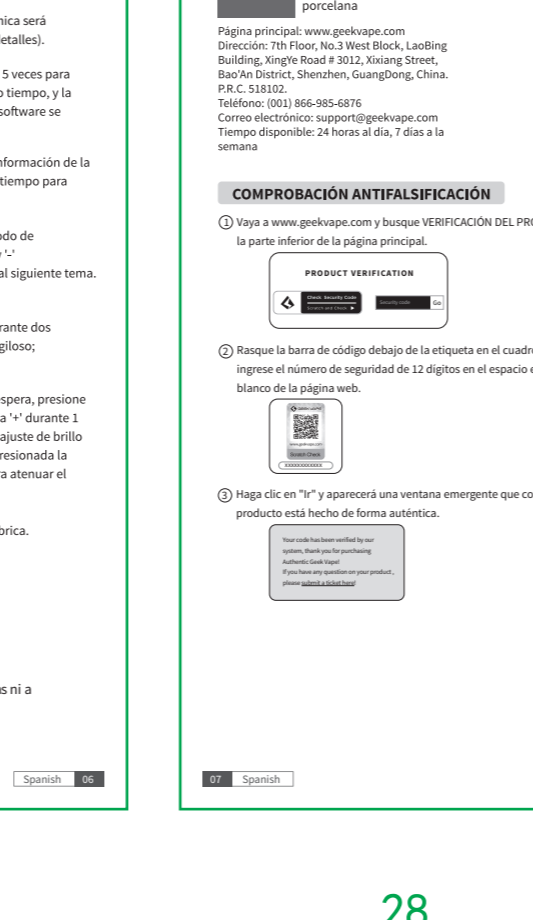

28

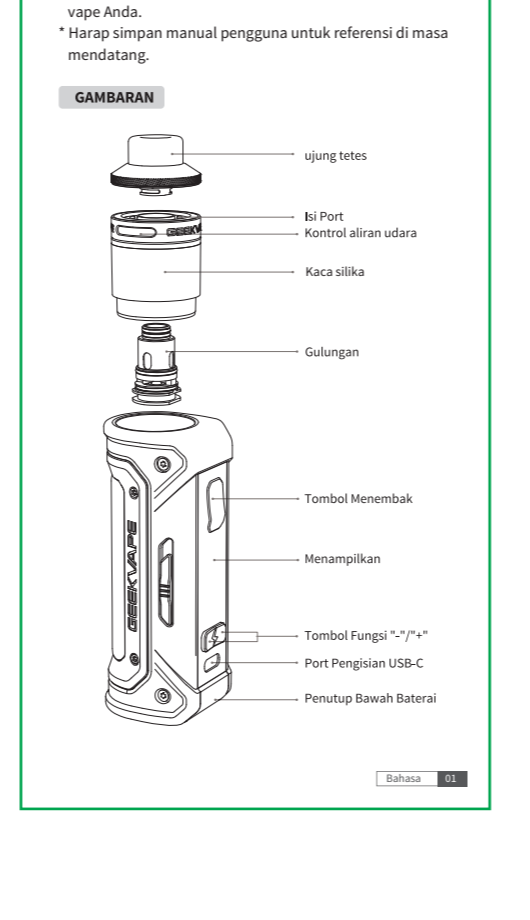

印尼语

57

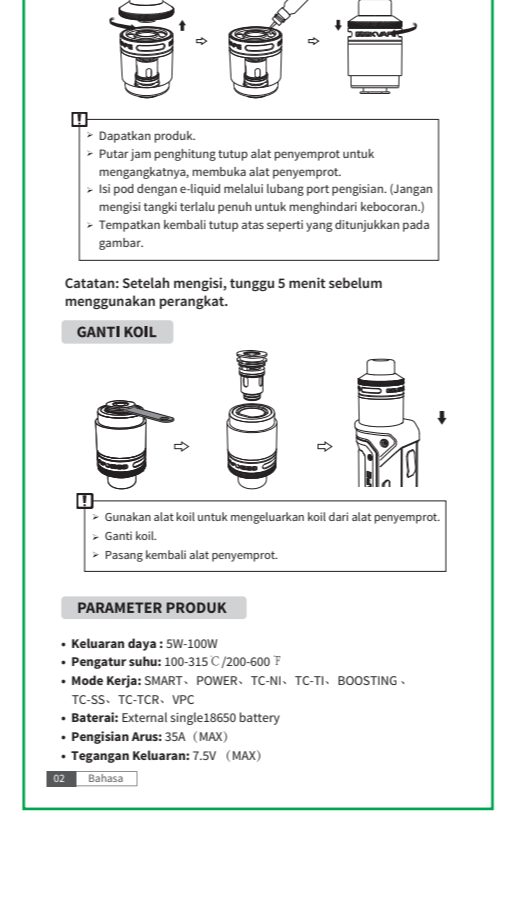

58

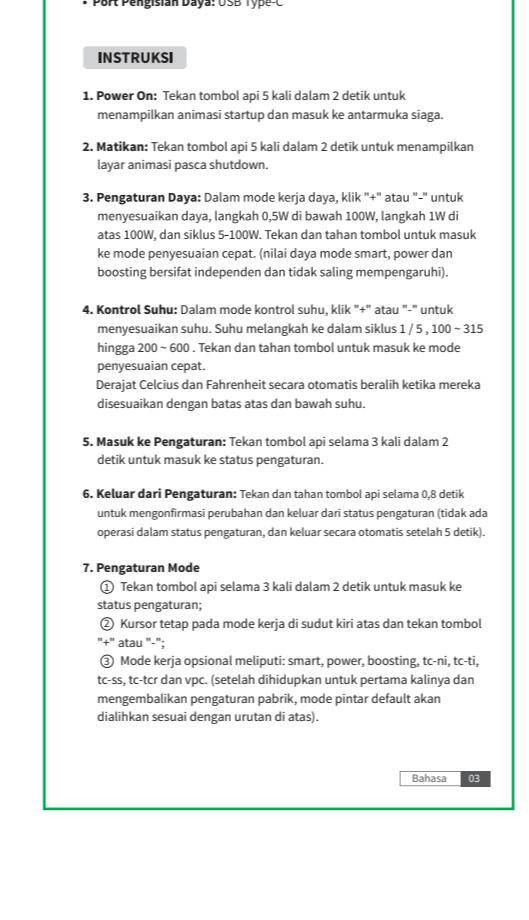

59

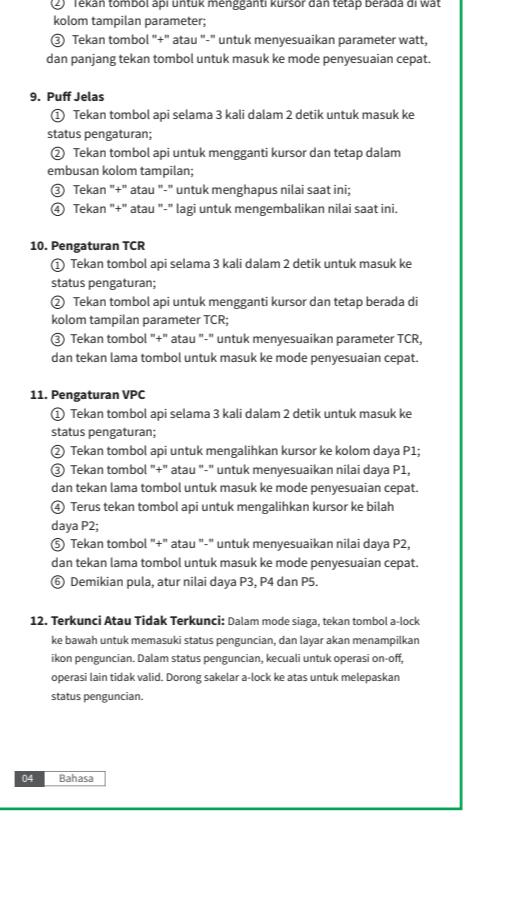

60

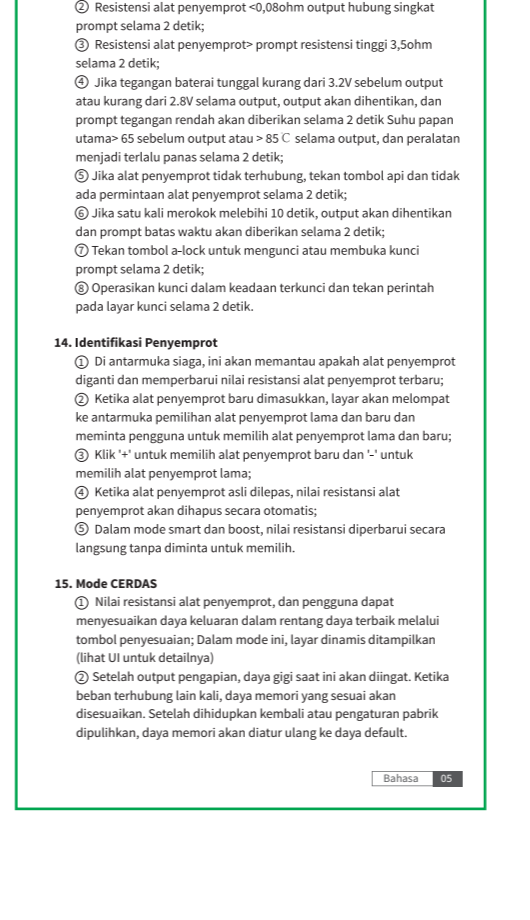

61

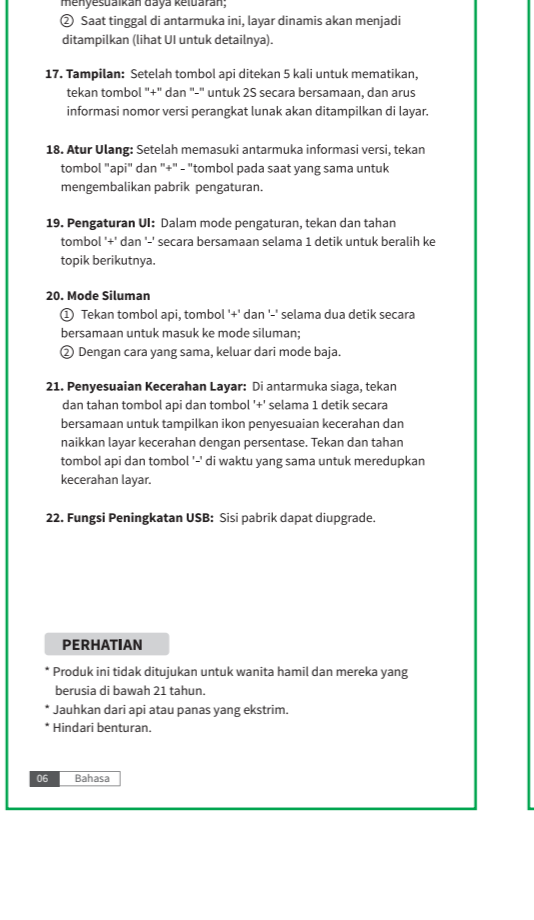

62

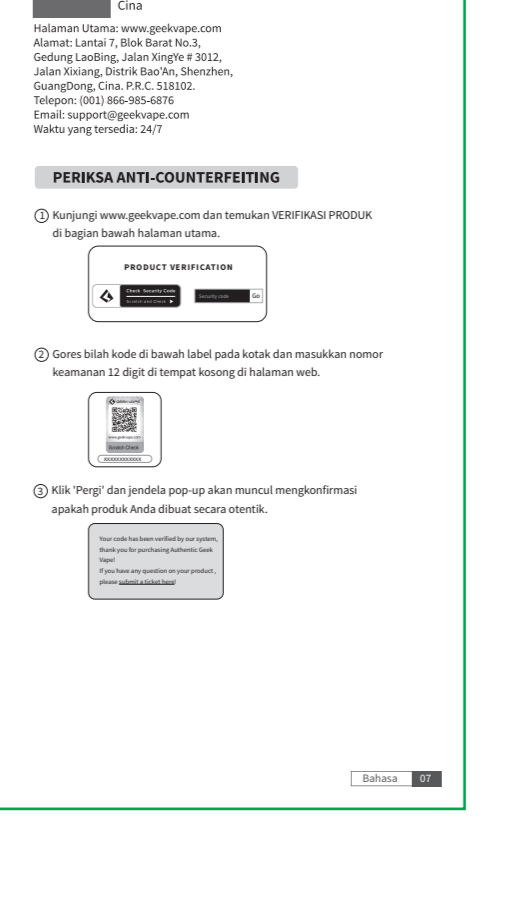

63

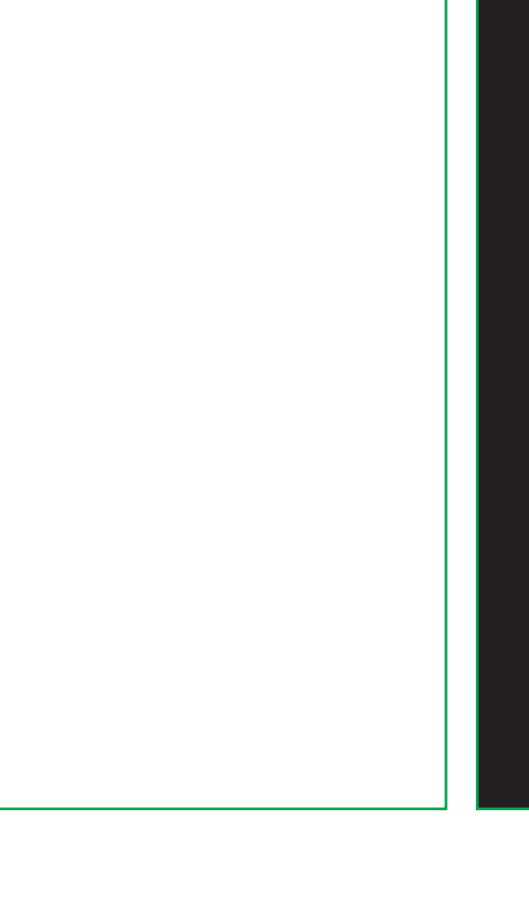
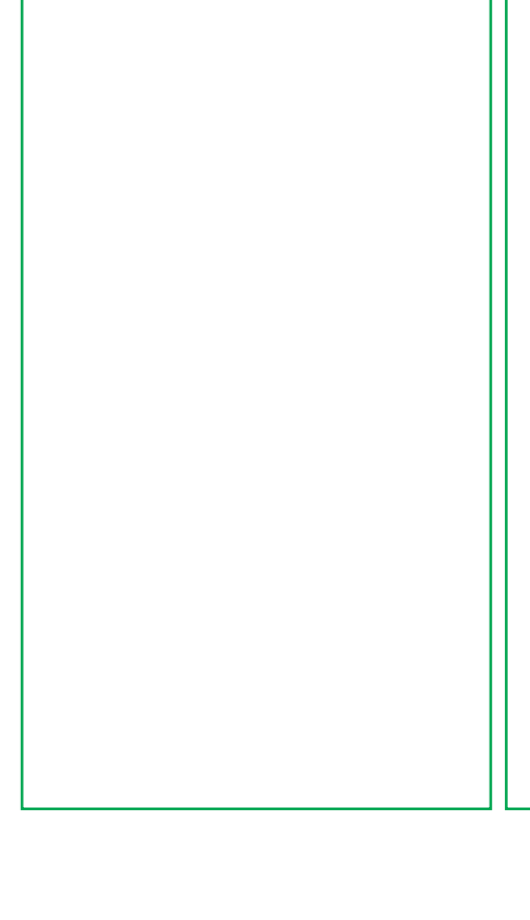

封底

- 要求:
1. 材料: 105g哑粉纸, 封面封底过哑油
 2. 成品尺寸: 62*120mm ≤ 0.5
 3. 工艺: 双面印刷, 骑马订, 68P.
 4. 颜色: 印单黑, 色差ΔE ≤ 1.00
 5. 油墨, 要符合欧盟为RoHS环保标准。
 6. 页码顺序依次按封面、1、2...50、68、封底印刷以文件为准, 严格按图纸做货。裁切边缘须整齐无毛边。

深圳市基克纳科技有限公司 Geekvakpe Technology co.,LTD		绘图 PRODUCTNAME	苏国才	比例 SCALE 1:1
		审核 CHECKED	2022/07/21	UNIT(单位): mm
未标公差 OTHER TOLERANEC	产品名称 PRODUCTNAME	GEEKVAPE E100 kit (Aegis Eteno) - 说明书	核准 APPROVED	REV(版本): A1
	产品编码 PART NO	GS0249		
	产品图号 PART NO	GS0249-P-18		