

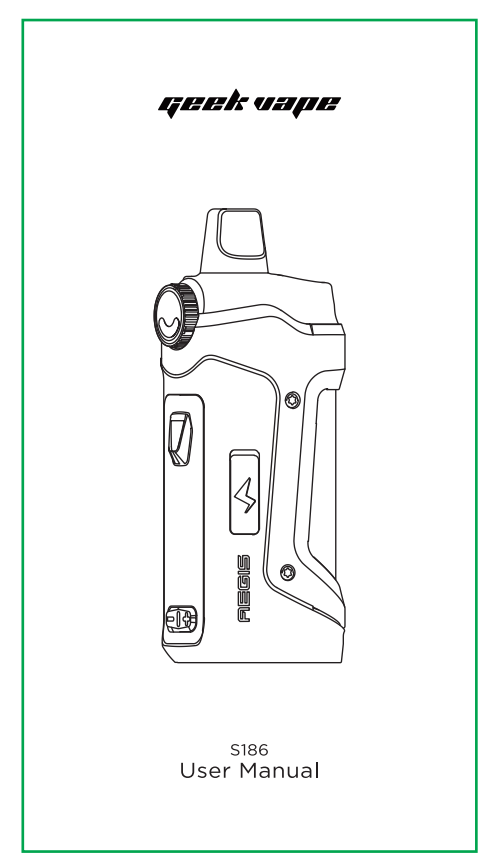

封底



封面

意大利

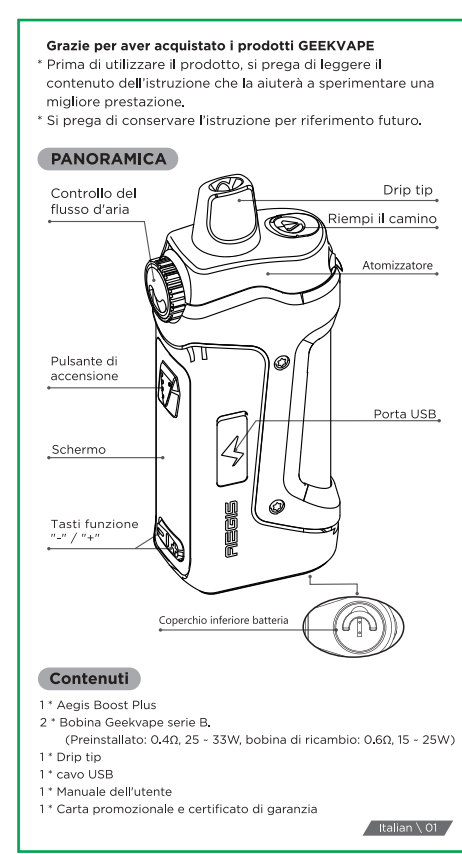

25

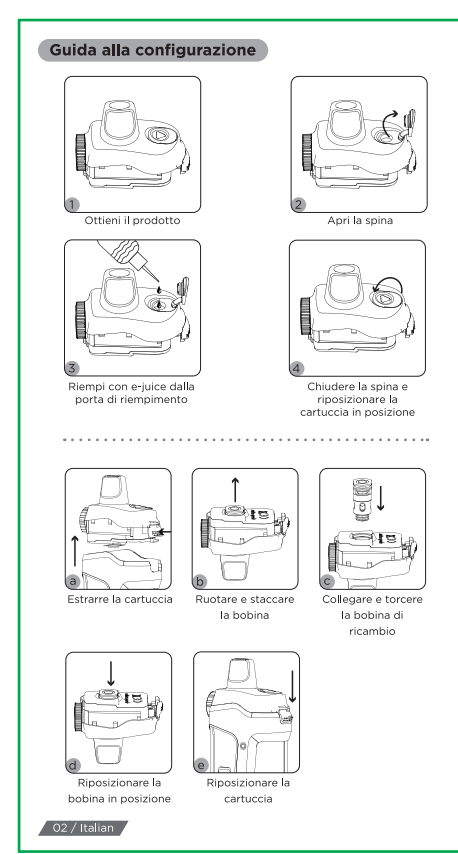

26

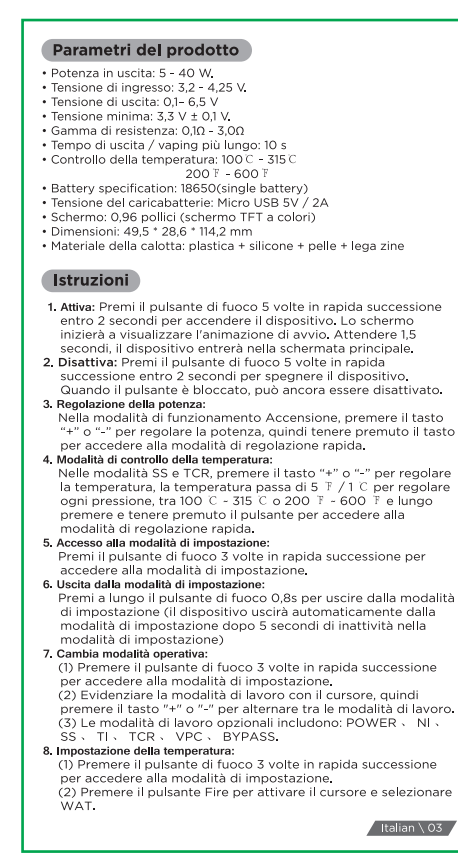

27

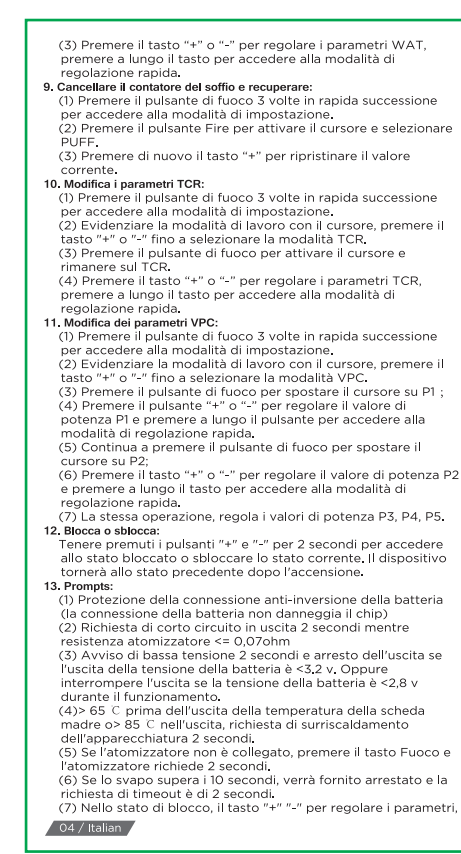

28

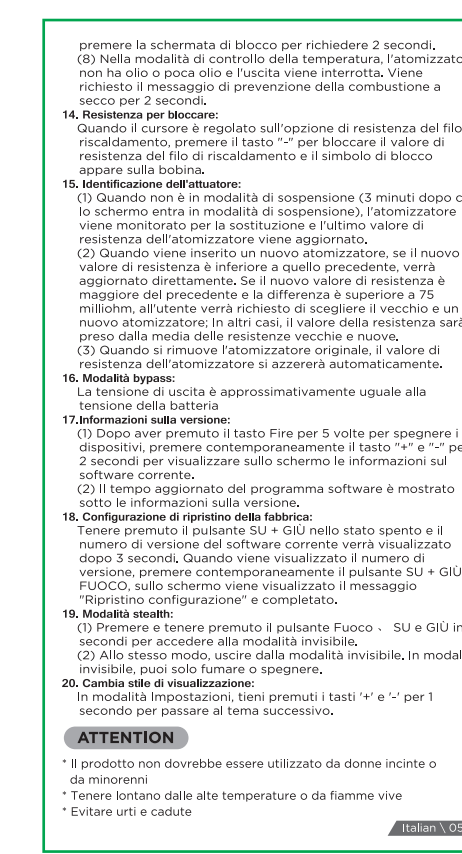

29



30

英语

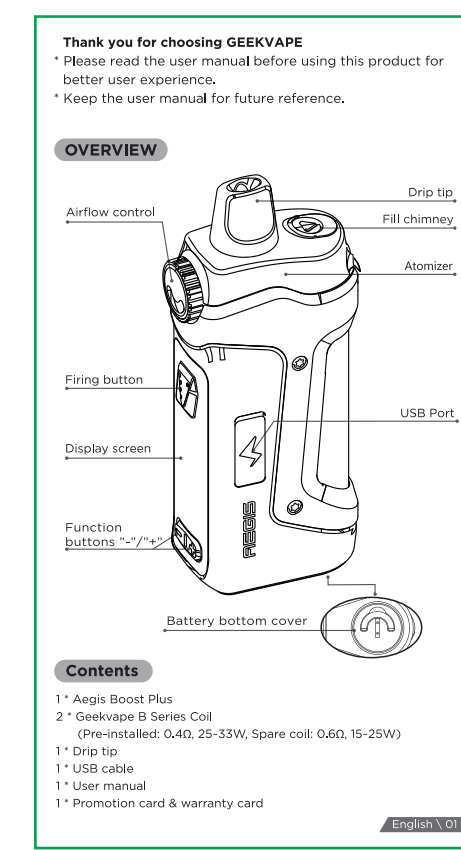

01

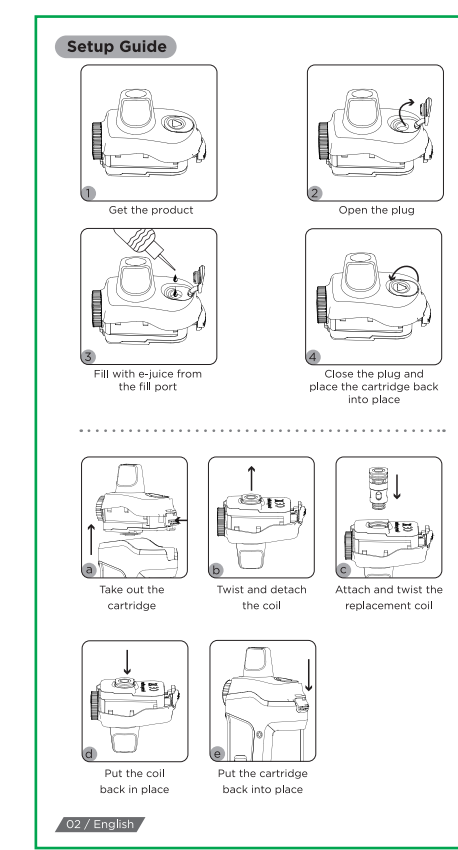

02

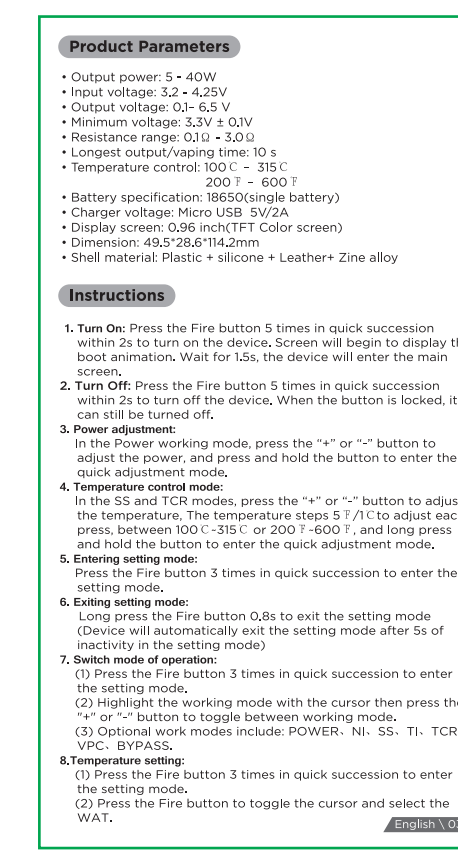

03

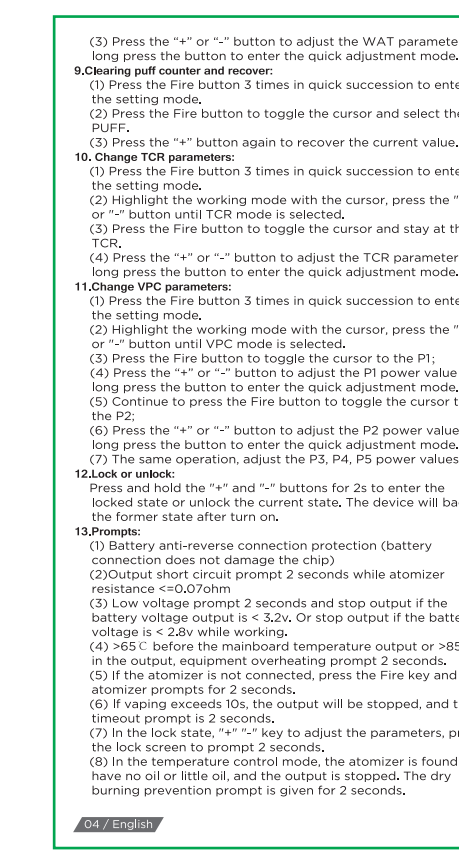

04

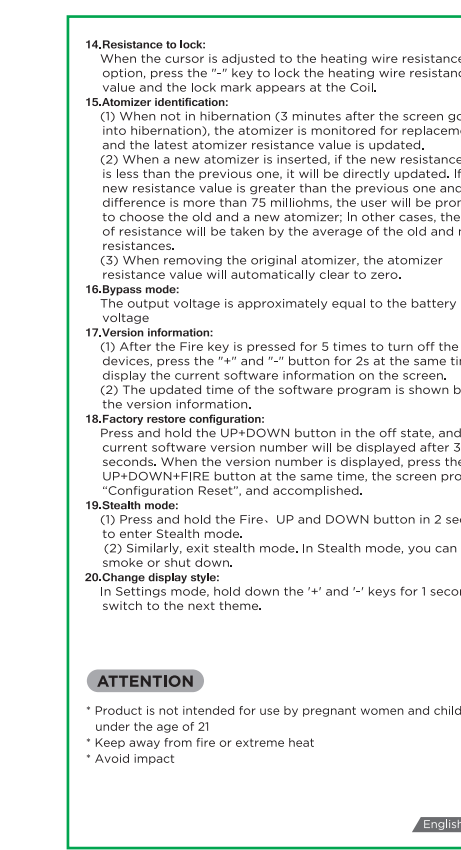

05

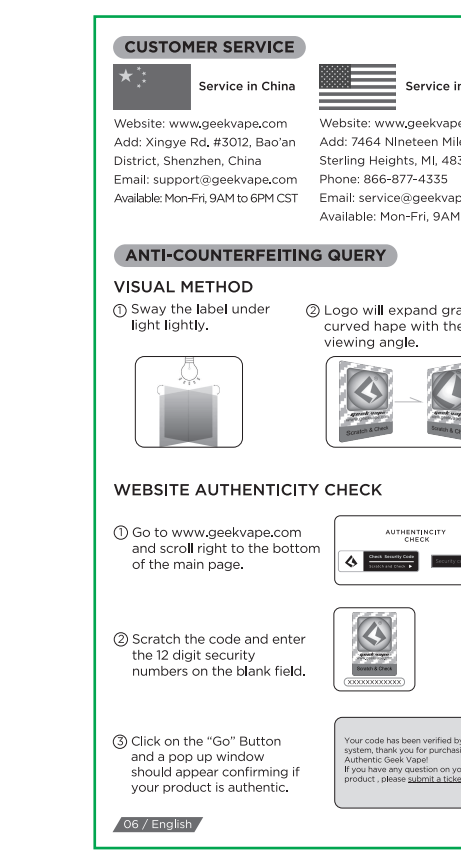

06

俄语

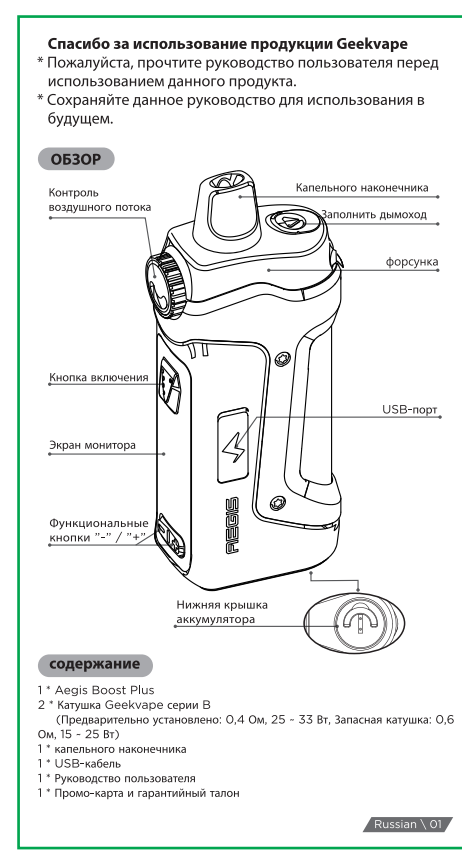

31

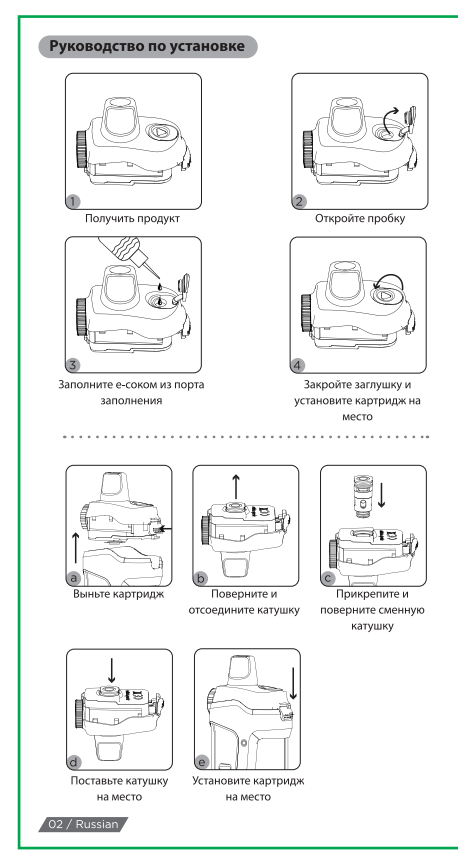

32

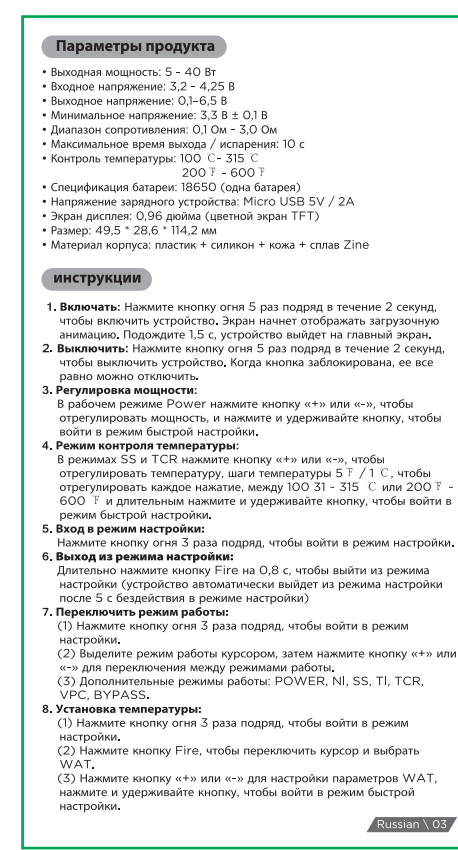

33

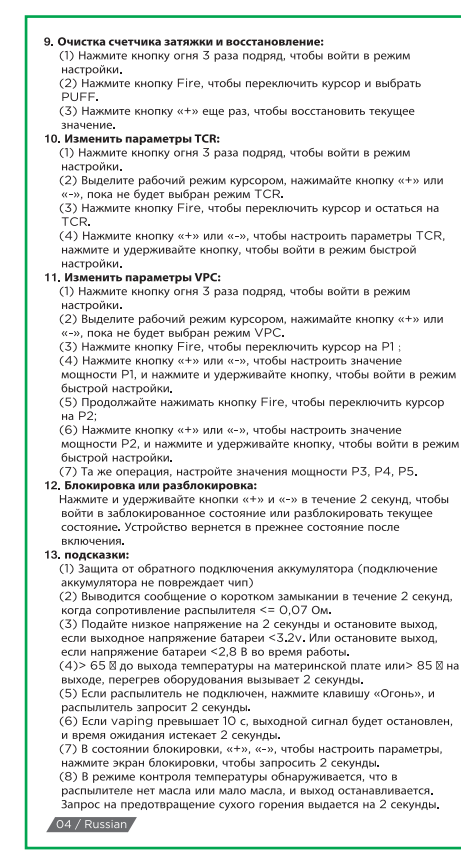

34

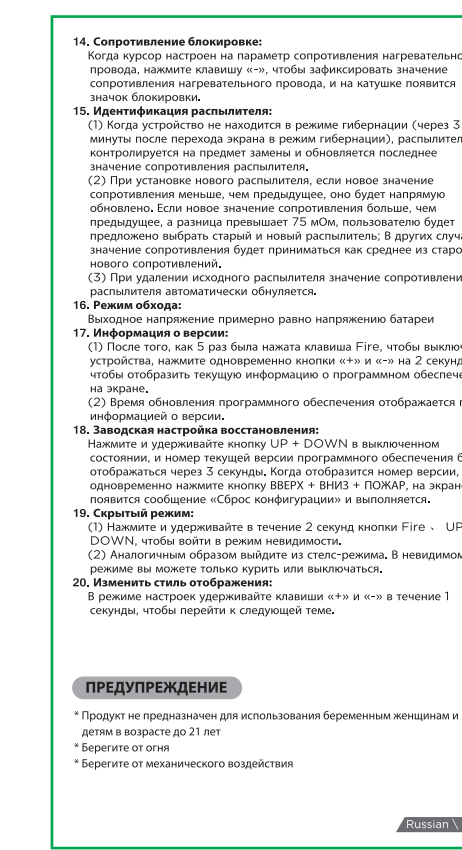

35



36

法语

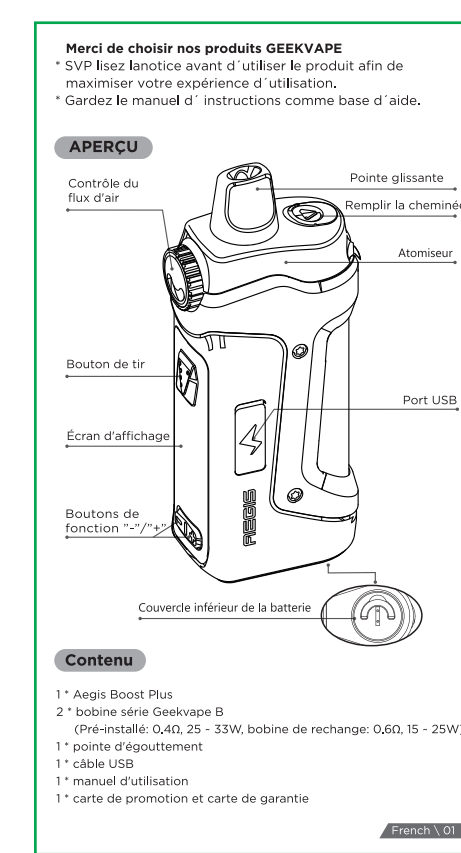

07

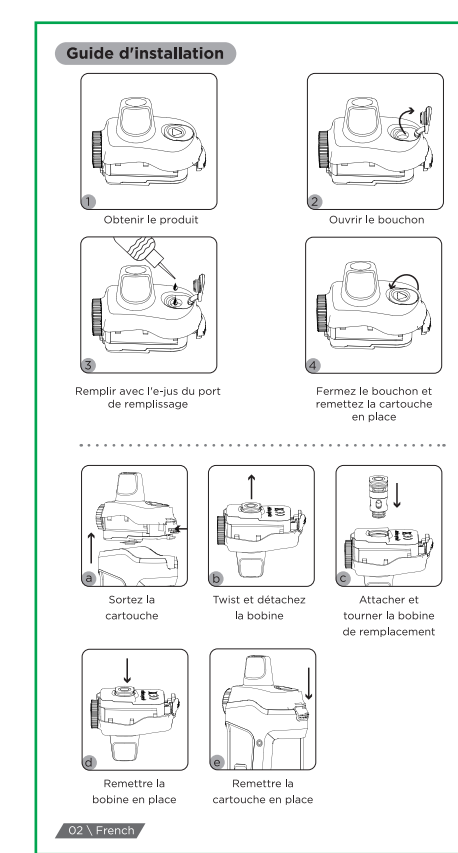

08

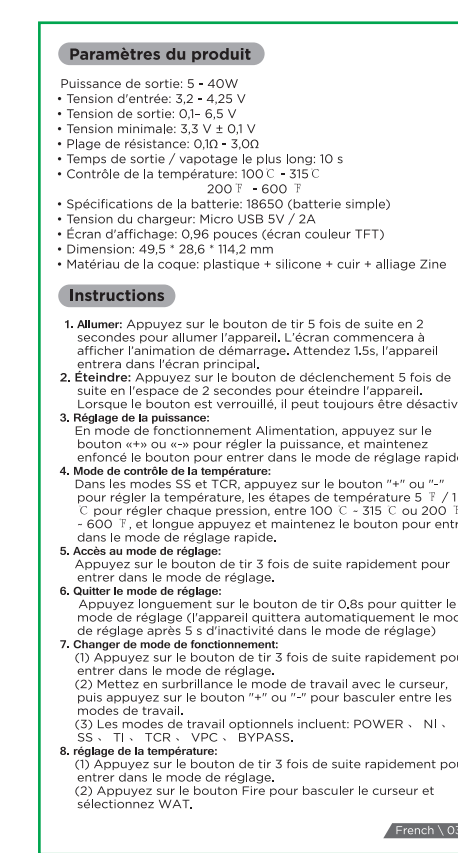

09

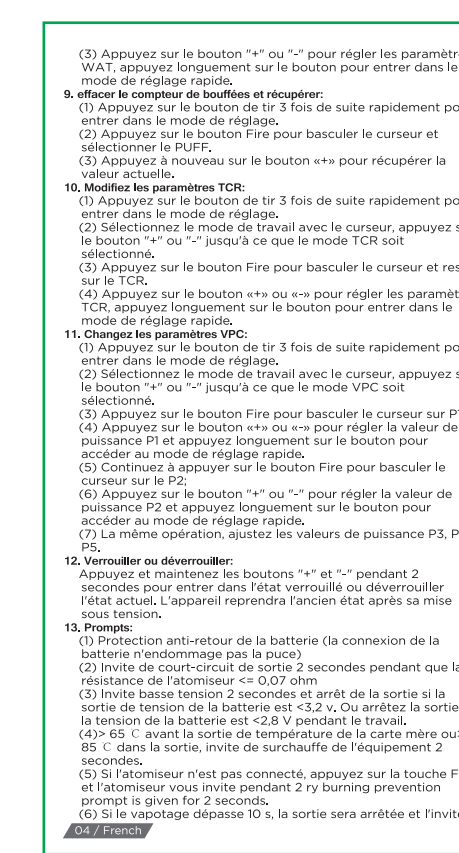

10

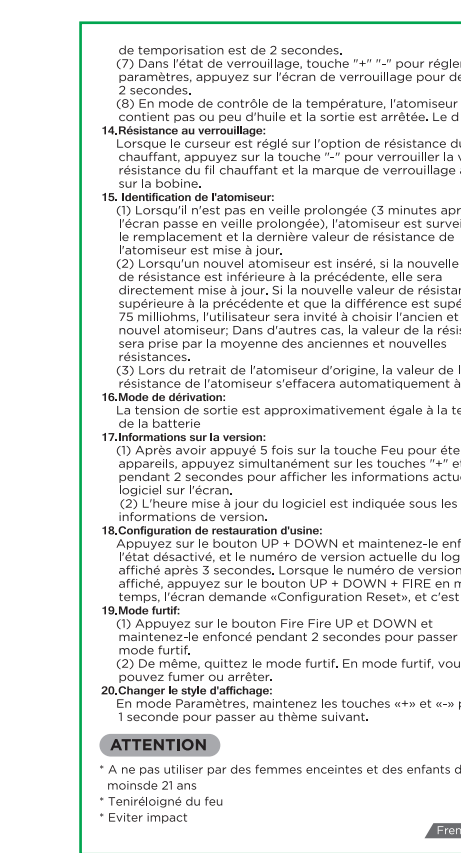

11



12

丹麦

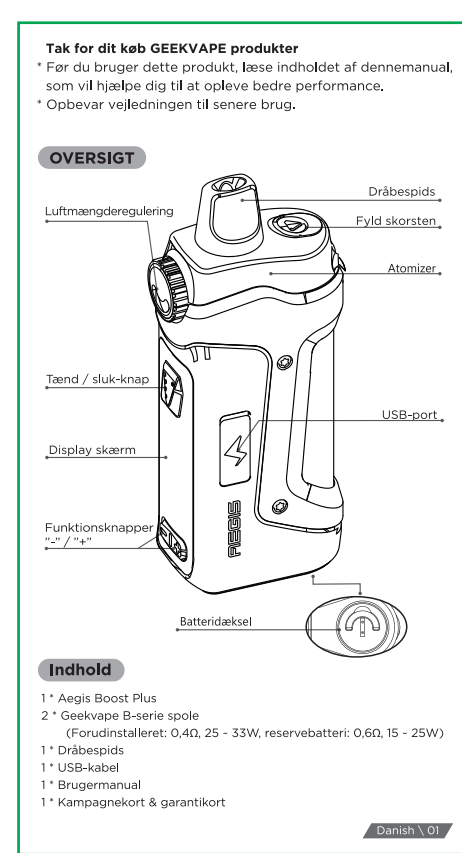

37

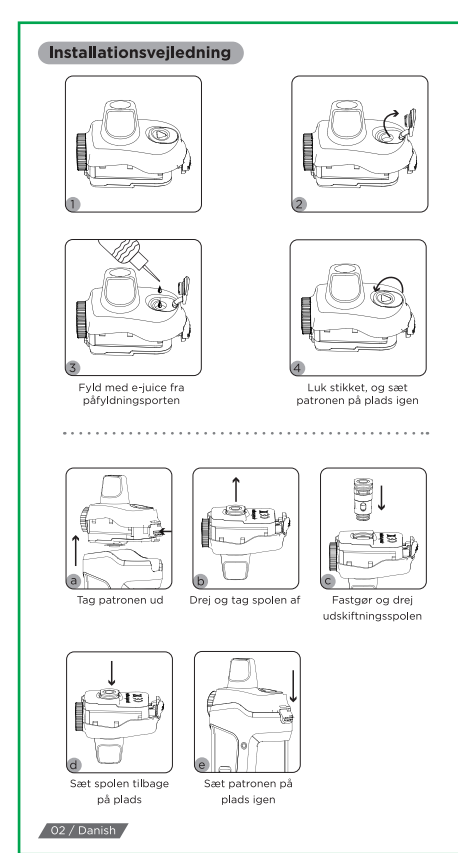

38

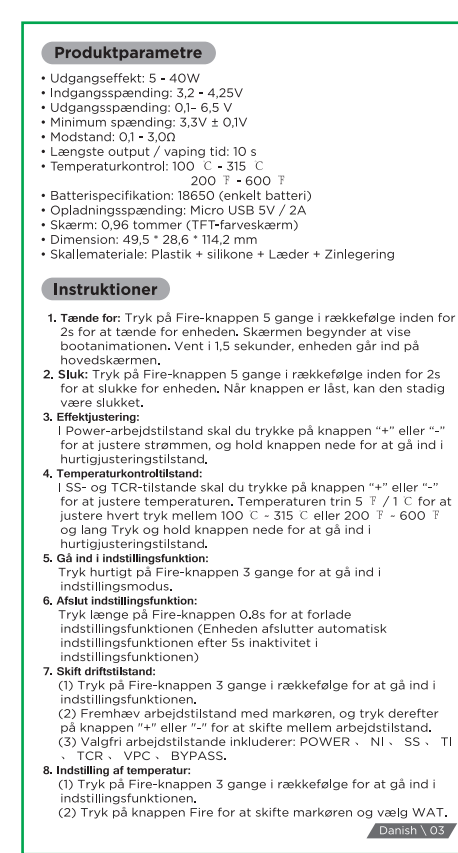

39

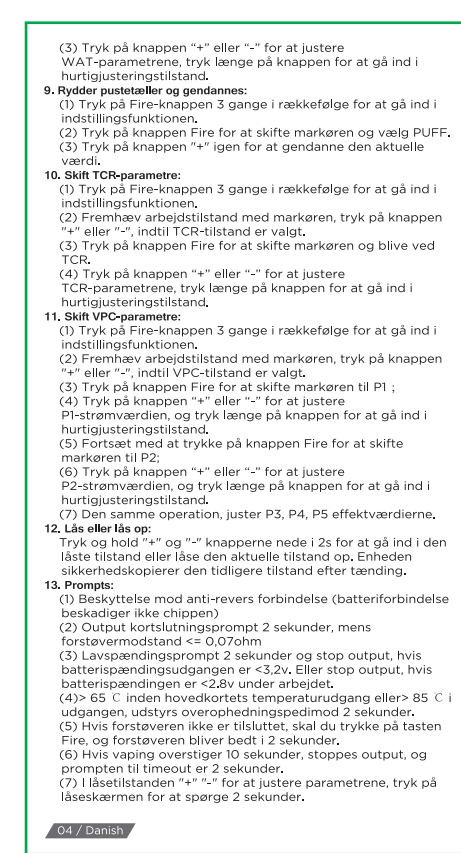

40

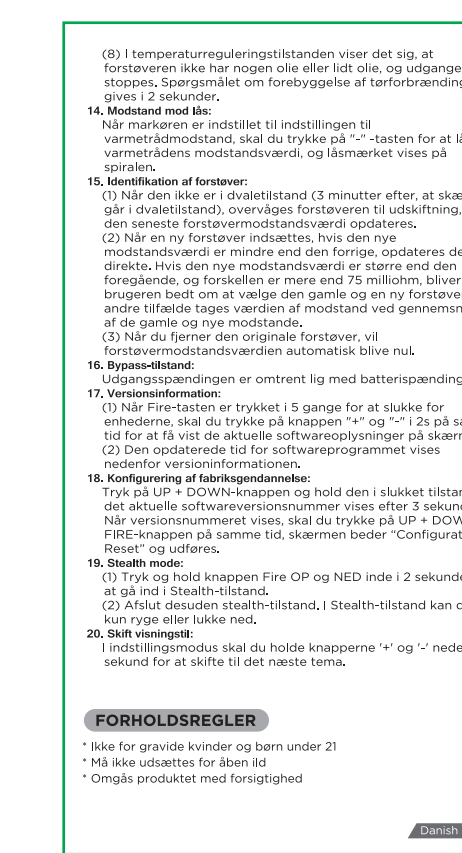

41

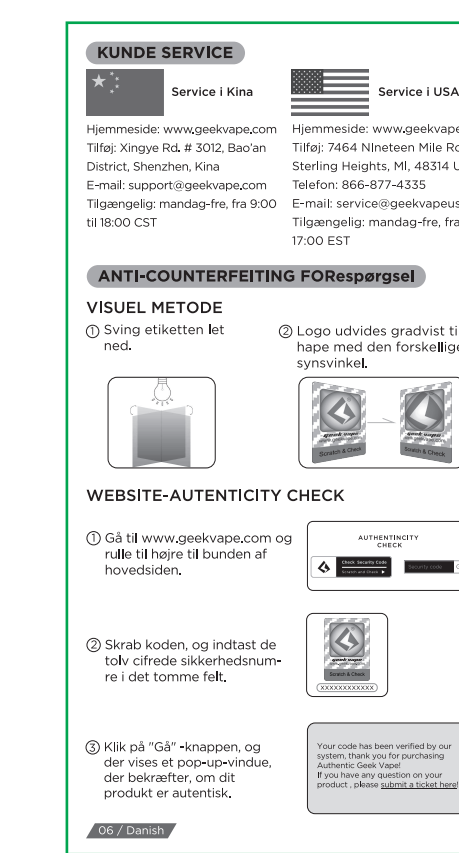

42

德语

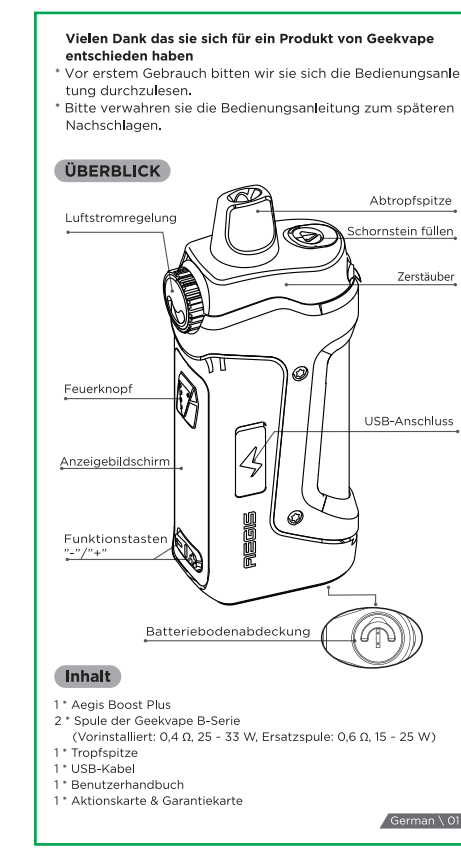

13

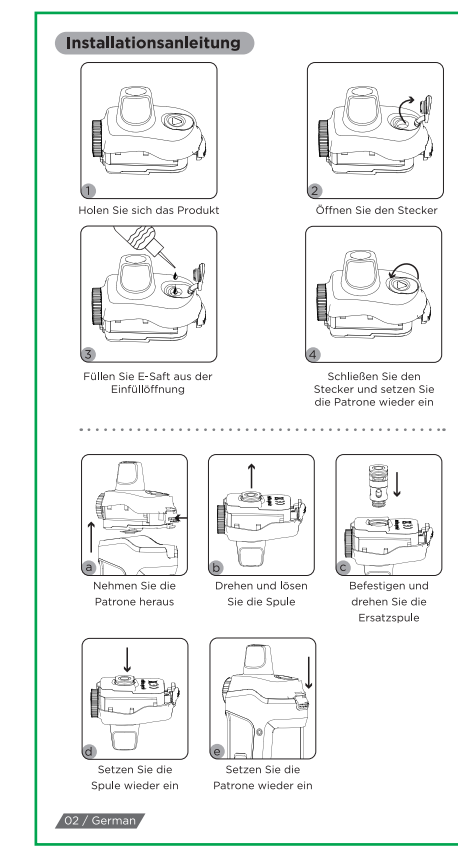

14

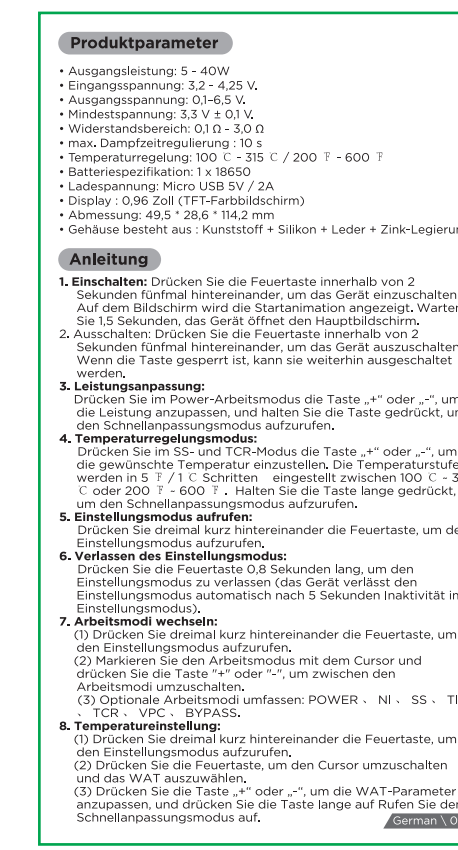

15

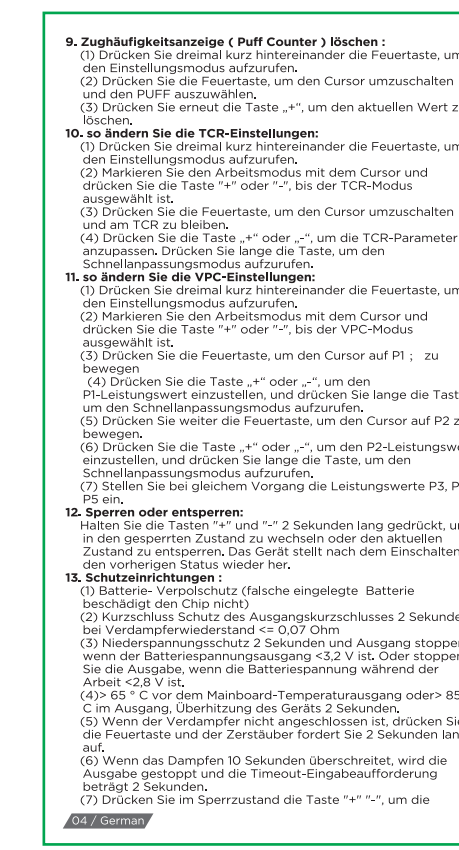

16

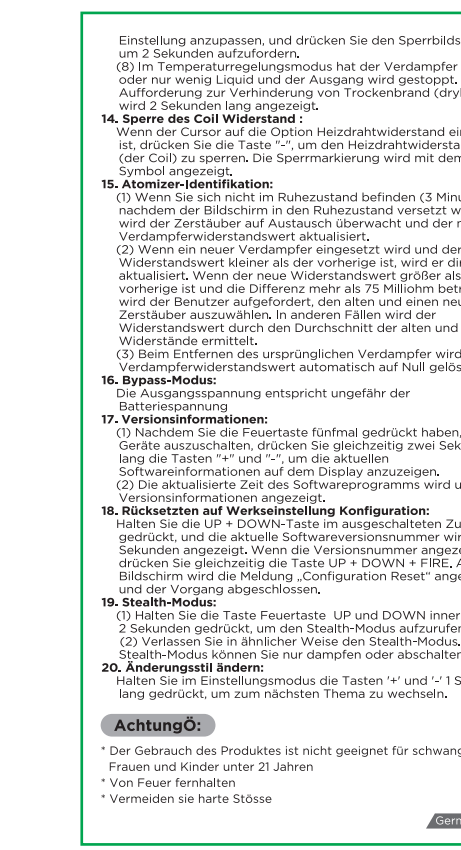

17

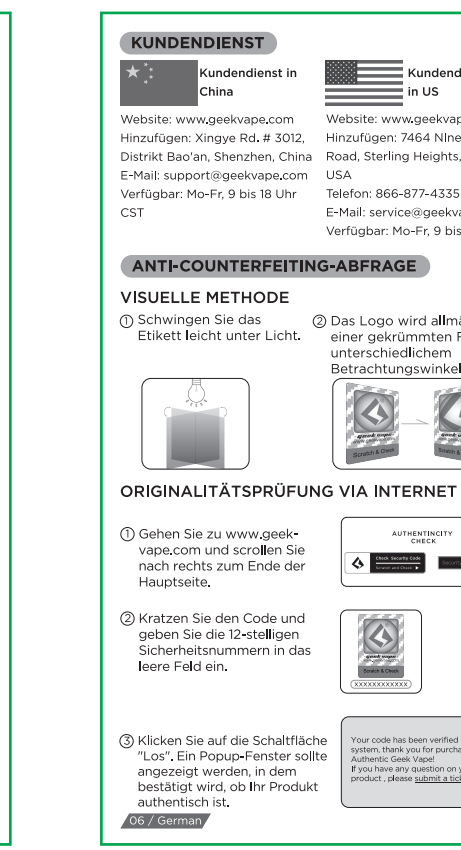

18

荷兰

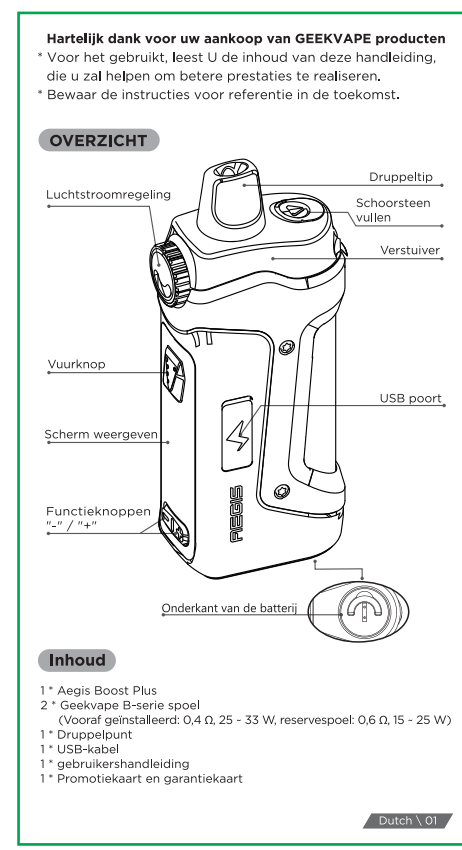

43

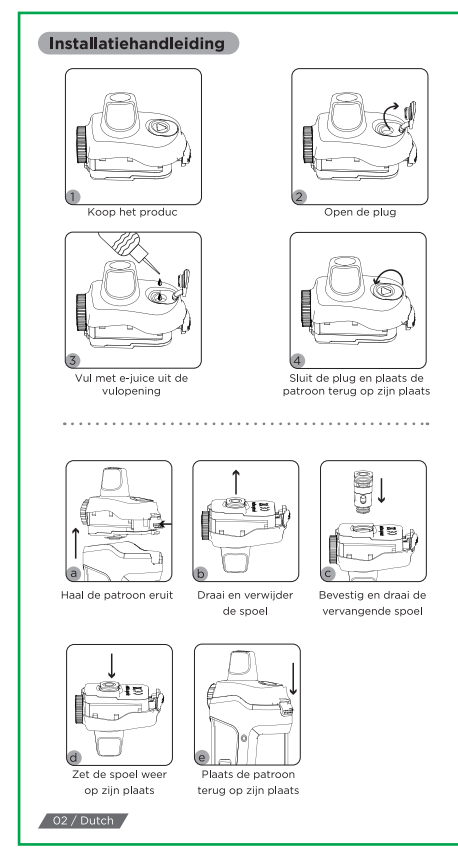

44

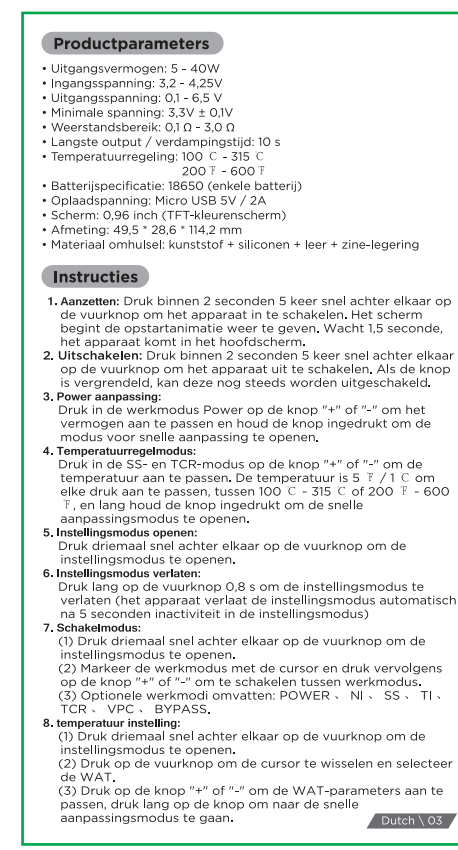

45

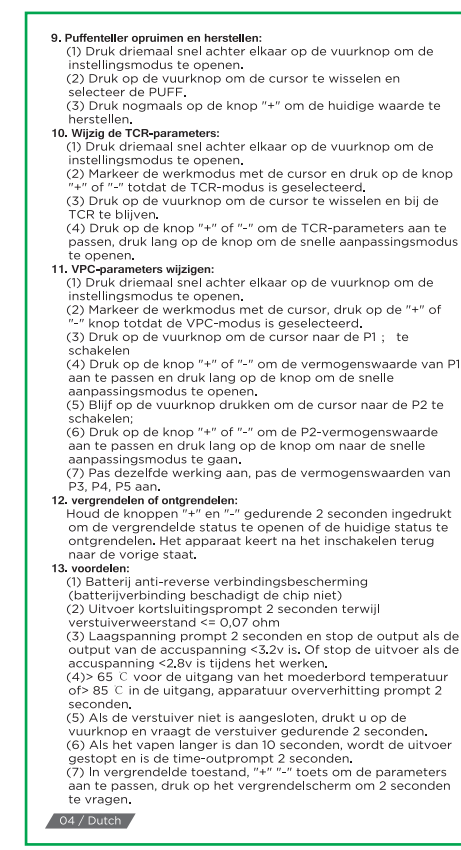

46

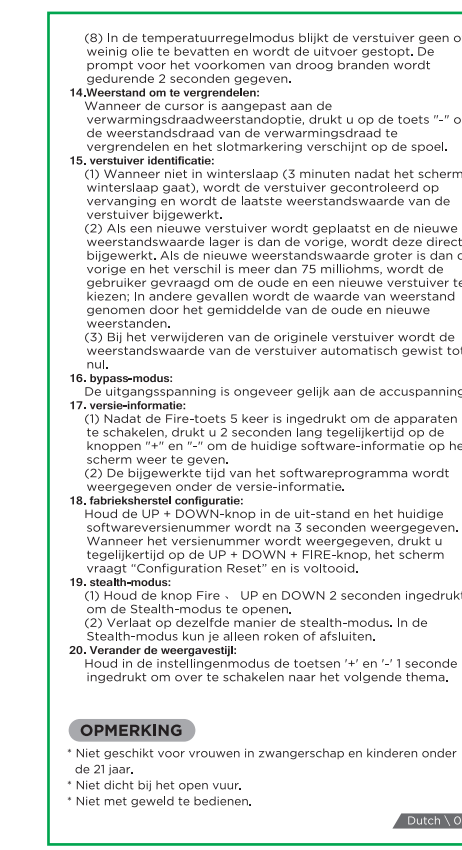

47

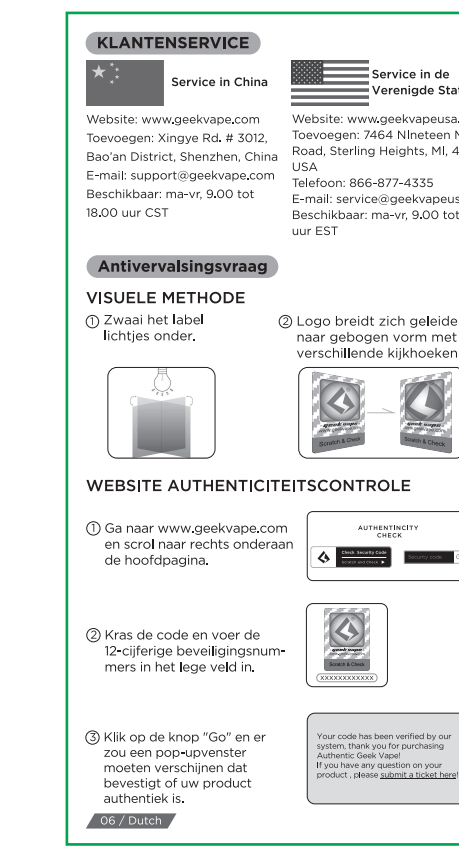

48

印尼

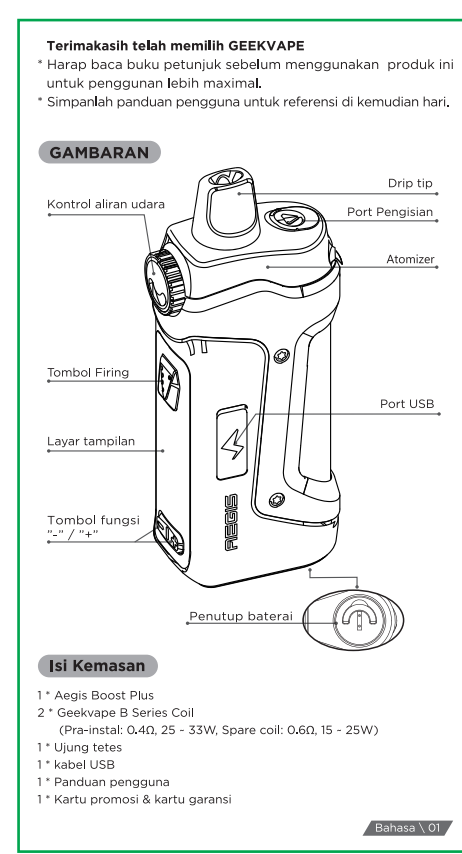

49

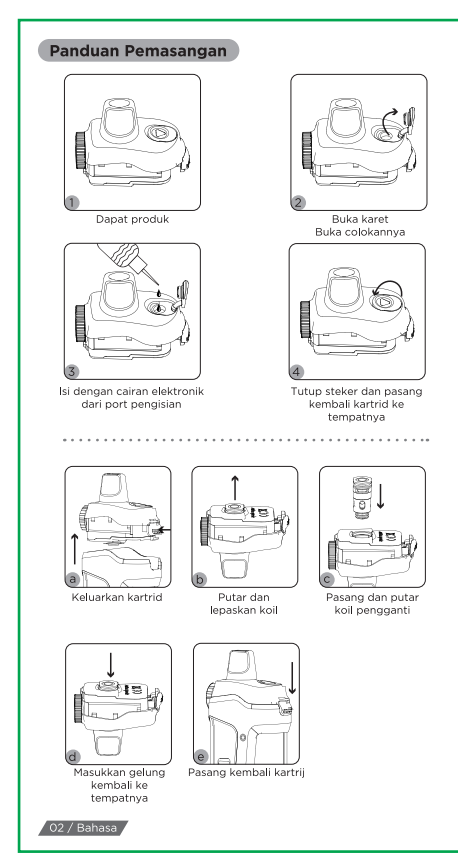

50

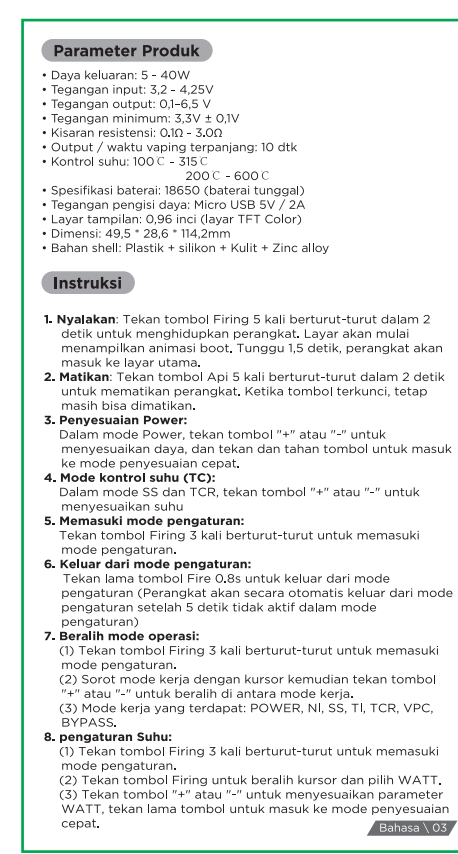

51

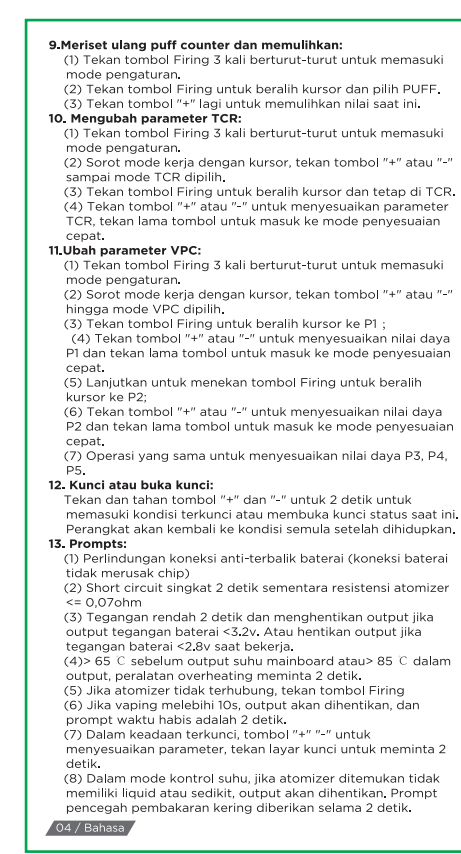

52

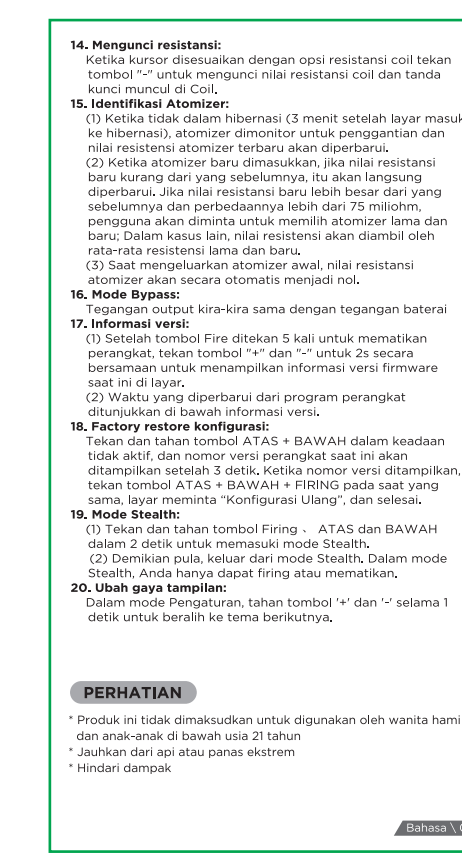

53

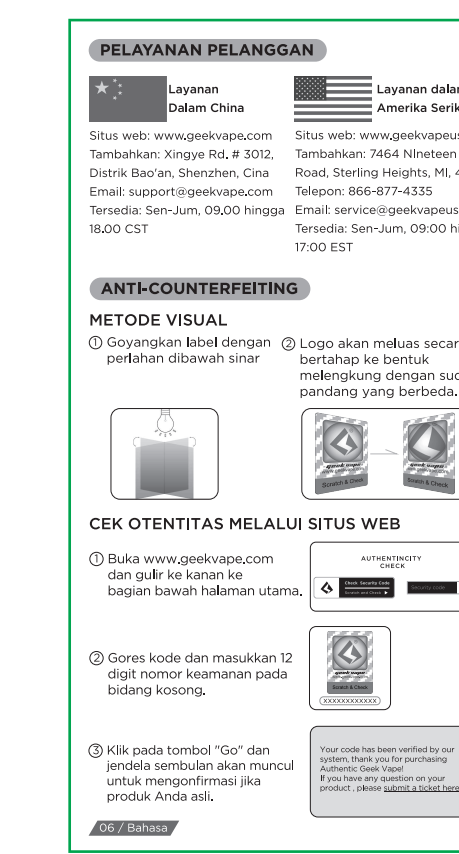

54

要求:

1. 材料: 80g书纸
2. 成品尺寸: 60*110mm ≤ 0.5
3. 工艺: 双面印刷, 骑马订装订。
4. 颜色: K, 色差ΔE ≤ 1.00;
5. 油墨, 要符合欧盟为RoHS环保标准。
6. 页码顺序依次按封面、1...54、封底
印刷以文件为准, 严格按图纸做货。裁切边缘须整齐无毛边。



深圳市基克纳科技有限公司
Geekvape Technology co,LTD

未标公差
OTHER TOLERANEC

产品名称
PRODUCTNAME

Aegis Boost Plus 说明书

产品编码
PART NO

S-186

产品图号
PART NO

S-186-P-09

绘图
PRODUCTNAME

容姣顺
2020/10/27

比例
SCALE 1:1

审核
CHECKED

UNIT(单位) : mm

核准
APPROVED

REV(版本) : A2

